



# Run 8

January, 2013

## President's Message

*By Bob Roth*

At this time I would like to wish all members of the ARM, family members, friends, supporters and everyone else a Merry Christmas and Happy New Year!!!

This has been a busy and interesting year particularly for me as I took on several new projects including teaching the Railroading Merit Badge for the Boy Scouts last January, developing a presentation on the history of the railroads in the Texas Panhandle and then presenting it for a few different groups during the course of the year, chasing tidbits of historical information pertaining to the local railroads and the Amarillo Stockyards, and more. I even spent time burrowing thru the photo archives at the Panhandle-Plains Museum down in Canyon looking for photos that have significance either for the model railroad layout and/or for one of my presentations. Every trip I made to browse thru the Museum archives I felt like a kid in a candy store as I found photos of various trains, buildings and events and given what I've found so far, I have many more trips ahead of me in the coming year.

I handled a number of requests for presentations during this past year with the most recently completed being a presentation on the "significance of the railroads" for the after-school program at Western Plateau Elementary School back on Friday, December 7. They split the kids into two groups, the Kindergarten and First Graders in the first group, and the Second thru Fifth Graders in the second group. It was a little rough with that first group with the younger kids, but I had a good time with the older kids bringing their attention to how much the railroads do for us; I heard a number of the kids saying they didn't know the railroads did that much for us after I finished the presentation. I also gave them all a safety message warning them that trains can take over a mile to stop thus they need to be careful around trains. When I finished, I received large thank you cards from both groups signed by all the kids and their teachers; very nice.

The most recent request I received was to teach the Railroading Merit Badge again this January at the Boy Scout Merit Badge University to be held on January 26, so I have more work ahead of me to re-check the merit badge requirements for updates and to prepare my material for this class.

Out around the ARM we had a few significant issues arise during this passing month that are proving relatively expensive as we work to resolve them thus I will mention them here so they will not be a total surprise to everyone at the January Business Meeting. First, we received information concerning renewal of our property and liability insurance policy and observed our premium appears to be

jumping almost \$1,000 over what we paid last year. I made an effort to investigate the cause for this significant increase in our premium and was informed the majority of the increase is due to an overall increase in property insurance rates across the State of Texas while a tiny part of the increase was because the property coverage limits were increased over last year's limits; at this time I am exploring options with our insurance agent to see if there are any other less costly alternatives but this bill will be due by mid-January however it is resolved. The second issue was that Tracy and I figured-out that our heating system at the building had quit working; it took us a little while to diagnose the problem ultimately finding out the valve actuators that regulate the distribution of hot water thru the floor slab had failed. I was in contact with the manufacturer of the heating system and was able to obtain the required part numbers and after chasing thru their primary distributor to a local supplier I can report that I picked-up two new valve actuators on Friday, 12/21, installed them on Saturday, 12/22, and when I finished, it appeared the heating system was back on-line. The third issue was that while trying to diagnose the heating system problem, Tracy found the small water heater that provides hot water for the restrooms and kitchen was leaking. We both looked at water heaters and Tracy picked-up a new 12-gallon water heater and managed to install it on Thursday evening, 12/20.

Concerning work on the HO scale layout, I managed to lay-out long pieces of L-girder along the walls where long straight pieces of L-girder will be required and then I started working on extension of the L-girder from Panhandle around the depth of the "U" where Cuyler will be located. Tracy continued building the spline roadbed extending toward Panhandle. David continued laying track around the curve into the North Amarillo area while Jerry continued working on wiring. Virgil Doyle has started work on fabrication of control panels for local control of turnouts and particularly has been working on a small temporary turnout control panel at Zita. Overall progress continues to be made on the layout despite short work sessions and the loss of the Saturday work days on 11/24 and 12/22.

Phillip Pratt Memorial Garden Railroad: No construction work was completed this past month given that it turns dark too early in the evenings to work on it on Thursdays and the weather has not been too conducive on our scheduled work Saturdays. I did order four new turnouts, two right-hand and two left-hand turnouts when I found a real good sale on the internet.

Next Meeting: The next Business Meeting will be on Thursday, January 3 at 7:30 PM. We may have a clinic following the meeting; Treasurer Virgil Doyle had asked a neighbor of his that works for the railroad to come and speak about aspects of his job for our clinic provided he is not called to work. If anyone has particular questions about operations on the railroad, you may want to attend so that you can get answers to those questions.

With a lot going on, I would like to wish everyone a very Merry (and Safe, and HEALTHY) Christmas and a Happy New Year.

Bob Roth

---

## MEETING MINUTES

**ARM Business Meeting**

December 6, 2012

Old Business:

Meeting Minutes from November: Published and distributed in Run 8 sent via e-mail.  
Approved as Published.

Treasurer's Report: Treasurer's Report for November:  
Treasurer Doyle noted we have our insurance coming due in the next month; the preliminary statement indicates the amount will be somewhere over \$3,200. President Roth has not looked thru the documents yet but intends to contact our insurance agent to discuss our policy.  
Treasurer's Report was Approved as Read.

#### Car Sales Report/Update:

Jerry Michels noted he had not been here for a number of months but gave a report noting our sales from September thru November; there has been very little activity thru our website and overall sales have been poor. One thing slowing down our sales is that all our car models are "old" and we have a lot more activity when we have new models to sell.

#### Layout Construction:

Progress: Tracy Ball completed the installation of the spline roadbed for the West leg of the wye at Canyon that feeds to the one loop helix behind the wall and completed the stretch around the corner from the North Amarillo area toward Panhandle. The bench work is completed all the way into Panhandle and we are ready to install risers and spline there. Several mounts have been installed for switch motors and Jerry has installed the PF-42 block circuit breakers installed; 6 or 8 are operational. Jerry noted that Bob Roth had reported a short in one area but Jerry felt that area should be dead since there were 2 sets of gaps cut in the track and it should be dead; he will check this out this Saturday. Efforts were made to initiate construction of the turnout control panels for the Zita and Amarillo Junior Yard areas. President Roth noted the Presidential Inspection Train was run on 11/24 and while it successfully ran down the stretch of main line track along Junior Yard some problems were encountered when it got to the curve between Junior Yard and Zita. Question was raised concerning turnouts; Tracy noted he had ordered a tool to grind the base rail for the switch points to meet against. He had not worked on any of the old switches yet as he has been working on his house in his spare time.

(Editor's Note: Switches have become a problem. Tracy had spent time looking at the FastTracks website and found links to a number of videos concerning construction of turnouts using the FastTracks templates and found the majority of our turnouts had been built wrong thus the reason so much work has been required to check each turnout and make adjustments. Tracy plans to build a couple of new turnouts before he tries to repair any of the existing turnouts. He thinks new turnouts can be built more quickly than our existing turnouts can be repaired.)

#### Phillip Pratt Memorial Garden Railroad:

President Roth noted he had leveled more of the roadbed for the outer-most loop of track early in November and he had discussed plans battery-powered radio control of trains with David Jusiak. President Roth also noted he has a friend with a G-scale layout at his home and this gentleman has one locomotive set-up with battery power and EasyDCC control (and a sound system) that he brought out to the ARM on Saturday, 11/26. The batteries were located in a boxcar with a removable roof making it easy to access the batteries to charge it. A stretch of straight track was set-up in the Meeting Room extending from the hallway at the restrooms to the front entry and the locomotive came to life when the connection was made between the locomotive and the boxcar with the batteries. We shuttled the train back and forth on this track

several times and John let President Roth's granddaughter operate it for a while; she seemed to particularly enjoy blowing the whistle. The control was real good. This led to a question and discussion concerning DCC systems; we probably don't want to buy a different brand of DCC system when we already have a Digitrax system. Issues include the matter we already have radio-controlled Digitrax throttles that should work and it would save the effort to learn a whole new DCC system. President Roth noted he had placed an order for four turnouts for the garden layout when he found a sale he felt we could not afford to pass-up with the turnouts priced at \$74.95 each; regular price is over \$100 each.

#### Building & Grounds Update:

Tracy Ball noted the lawnmower has been repaired and he has done some mowing these last couple of days. He noted things were extremely dry and he ate a lot of dust; one needs to wear a dust mask when mowing at this time. Mowing and weed-eating is still required. Fortunately the growing season has ended, so there is a chance to catch-up with the mowing.

Heating: The heating system had been turned-on a couple of weeks prior to this meeting. President Roth questioned if one of the heating valves was operating correctly as he had observed the thermostat in the Train Room was calling for heat, but the pump had not kicked-on. The Meeting Room was comfortable at the time of the meeting.

TV antenna on the West end of the building tore-loose from the building and is laying on the ground needing to be re-installed.

ATCS Antenna: Final resolution needs to be discussed by the Executive Board. Five of six Board members were present. It was noted we still have our power pole from the Roberts Street property and we could put our TV antenna on it as well as the ATCS antenna. Members of the Board concurred this would be a good solution. The one issue is moving the pole from Tracy's property to the ARM; Tracy noted when we go to fetch this pole we need to fetch all the track material too. The track material consists of around 20 pieces of rail and maybe 50 cross-ties. Question was raised about selling the rail on Tracy's property for scrap; we will check into the price for scrap and if we might need to cut-up the rails as President Roth had investigated this issue several years prior.

#### News from Other Organizations:

Santa Fe Museum: No recent news.

RAPS: No recent news. They were open the day the 844 came thru town including having a truck pulling a trailer with a banner proclaiming "Follow me to the Madam Queen."

NMSLRHS: They continue working on restoration of ATSF 2926 in Albuquerque. They sent out their newsletter around the 4<sup>th</sup> of December and President Roth had printed and brought out a copy of their newsletter if anyone is interested. Issue they have been working on this locomotive for the last 10-years and anticipate 2 more years to complete the restoration. They have a pretty good membership with a lot of people with special skills helping with the restoration work.

Recent/Current Promotions: No new promotions beyond what was done last month.

Request for Presentation: President Roth is planning to give a presentation for the afterschool program at Western Plateau Elementary School on the significance of the railroads on 12/07 at 3:30 PM.

President Roth noted one new request for him to do the Railroading Merit Badge for the Boy Scouts.

Rock Island Stuff: Guy Pigg reported he is playing phone tag with the lady that is looking to sell her Dad's Rock Island Conductor's Uniform and other items.

Donation from Don Dean: No new information this past month. Jerry stated he had issued an invitation to Don to come out to our meeting this evening.

Cub Scout Visit: No further news; David will see the Den Leader later this week.

Housekeeping Schedule: Andy and Beverly had come out and cleaned over the weekend. The months of January, November and December are still open.

### New Business:

Insurance: Notification had been received a week ago stating the bill was to be coming. Last year our liability and property insurance policies had been combined and we got a rebate, but preliminary indication is that our rates have jumped significantly for this coming year thus President Roth is going to make some calls to investigate this.

Notification Problem: There had been a problem with our e-mail notifications where the times for our weekly meetings and Saturday workdays were drastically changed. Guy Pigg believes he managed to fix this problem; he had not set-up the time zone correctly.

E-mail message received from an Amarillo College student (Ashley Overeynder) with an assignment to write a paper about a form of art at a museum and she would like to use the ARM. No further contact had been received on this.

Railroading Merit Badge: As noted earlier, a phone request was received from Scott Killian with the Boy Scouts asking President Roth if he could do the Railroading Merit Badge class at the University of Scouting on 1/26. President Roth had said yes.

Clinics: Virgil Doyle had previously mentioned he had a neighbor of his that is a locomotive engineer that he had asked to come and talk with us about his experiences on the railroad. Virgil had forgotten to call him and he will make a note to call him next month. If he is unable to show-up, we can show a video that Jim Shook brought out.

Television: President Roth noted he had forgotten to mention this previously; Jerry and Judy Michels had graciously donated a new 42-inch TV to the ARM and it was hooked-up back on November 10. In experimentation despite the lack of an antenna, we found we could receive a faint TV signal over the air with our dangling antenna cable. It was questioned if we can view video on this TV at the moment. An HDMI cable needs to be secured to connect a blue-ray player to the TV.

Protection of Painted Walls: David Jusiak brought up the issue of us needing to protect all the work that was done against a future invasion of the moths. We had a major invasion of Millers moths this past Spring and we found where they had pooped on the walls the walls were stained; the stains had eaten into the paint where it would not wash-off. A number of different

cleaning agents were tried and the best was the Mr Clean Magic Eraser, but the damage was done. Tracy noted he had tried to paint over some of the spots and they bled back thru the paint thus we probably need to touch-up over the spots with KILZ so that we can repair the damaged paint. We need to find a good clear coat we can apply over the walls to protect them in the future.

ARM Work Dates:   December 8  
                           December 22  
                           January 12  
                           January 26

Next Business Meeting: Scheduled Date is Thursday, January 3.

Meeting Adjourned.

**Future Events:**

Dec. 7, 2012	Presentation on significance of the railroads to Western Plateau School at 3:30 PM by President Roth.
Jan. 26, 2013	Boy Scout Merit Badge University – Railroading Merit Badge
May 29-June 2, 2013	Lone Star Region (NMRA) Convention in Dallas-Fort Worth Sheraton Dallas-Fort Worth Hotel
June 6-9, 2013	“Rails along the Rio Grande” hosted by Rio Grande Division #6, Rocky Mountain Region, NMRA. Albuquerque Marriott Pyramid North
July 31-Aug 4, 2013	Santa Fe Railway Historical & Modeling Society Convention in Flagstaff, Arizona

**Cleaning Schedule for 2012 / 2013:**

December	Andy & Beverly Lyle
January	
February	Tracy Ball
March	Jim Shook
April	Jim Shook
May	Jim Shook
June	Jim Shook
July	Jim Shook

August	Jim Shook
September	Jim Shook
October	Jim Shook
November	
December	

---

Classified Advertisement:

For Sale: Three (3) 8-foot long HO scale railroad yard modules; 24-foot long yard built to NMRA standards. Steve Coffman 806-787-9961

---

Recent Photographs:



New spline roadbed extending toward the location of the City of Panhandle on the layout. Elevation of the spline is dropping.



Looking back toward Panhandle from Cuyler.



L-girder clamped in-place at Cuyler as it is being checked for level before permanent installation.





This is one of the new heating system control valve actuators installed on Saturday, 12/22. In this position the valve is open and hot water is circulating thru the system heating the building. This actuator is equipped with an end switch that turns-on the pump after the valve opens.



# Run 8

February, 2013

## President's Message

*By Bob Roth*

As I finally sit down to write this message most of the month of January is already gone. I had received a request a while back asking if I might teach the Railroading Merit Badge to the Boy Scouts again this year at their "University of Scouting" on Saturday, January 26. That said, much of my time these last few weeks has been spent preparing a new PowerPoint presentation to cover the majority of background information behind the merit badge requirements. I just finished the class a few hours ago with a group of thirty-four (34) Scouts in attendance and now I finally have the time to sit down to work on Run 8.

During the course of this past year I have kept my eyes open for a few specific items to photograph to support this merit badge presentation. As an example, one of the requirements on grade crossing safety requires the Scouts to explain the appearance and meaning of the advance warning signs and pavement markings posted in advance of railroad crossings, and the cross-bucks, flashing red lights and crossing gates at railroad crossings. During one of my meandering trips a number of months ago I found one grade crossing that was equipped with all these features and I took a picture so that I would be able to show all of these features during my presentation. The more difficult part was hunting back thru all the pictures I've taken over the past few years with my digital camera to find all the pertinent photos to slide into my presentation; this took a bit of time and I actually didn't quite finish the whole presentation, but at least it was about 95% complete. Now I can take my time to fill-in the remaining holes.

The requirements for the Railroading Merit Badge cover various aspects of the prototype railroads including identification of modern freight trains, explaining why unit trains are more efficient than mixed trains, explaining how a modern diesel or electric locomotive develops power, the purpose and formation of AMTRAK, planning a trip by rail using a timetable, learning about safety along the railroad, grade crossing safety, Operation Lifesaver, railroad signals and going as far as looking at career opportunities in the railroading industry. There are several additional requirements above and beyond those mentioned above and the merit badge has some optional alternative requirements that step into railfanning and model railroading. If anyone is interested, the requirements for the merit badge can be found at [www.meritbadge.com](http://www.meritbadge.com).

Out around the ARM, the weather has not been very conducive to work on the garden railroad or on any other tasks outdoors thus all our efforts have been focused on the HO scale layout inside the

building. Fortunately the heating system has been working very well since I replaced the heating system control valves last month and the inside of the building has been very comfortable for working on the layout. The Executive Board met briefly the week after the Business Meeting at the beginning of the month with some discussion concerning membership in the ARM and how to build the membership. The main point the Board felt is critical to attracting new members to the ARM is that we need to get a good part of the model railroad layout up and running. Per the Board, the main focus at this time is to build bench work for the layout with the goal to build the bench work and then fill-in the roadbed and track on the lower level giving us a long run between the lower level staging yard and Amarillo Junior Yard. To this end, we made real good progress during this past month completing the bench work from Panhandle around the curve thru Cuyler and Kingsmill, and then on the other side of the peninsula all the way thru Pampa. This forced us to do a little clean-up to move stuff out of the way for the bench work thus all-in-all, we got a lot of work done in a relatively short time. On Thursday, January 24, we worked on the L-girder going around the end of the peninsula connecting Kingsmill with Pampa thus we are very close to turning the next corner. Tracy also surprised us by extending the spline roadbed from Panhandle thru Cuyler on into Kingsmill creating the need for some track laying. It is exciting to see this much progress on the layout in such a short time.

Next Meeting: The next Business Meeting will be on Thursday, February 7 at 7:30 PM. We will have a clinic following the meeting; we have a guest speaker, Michael Chavez come to talk about his experiences years ago riding the White Train.

Bob Roth

---

## MEETING MINUTES

### ARM Business Meeting

January 3, 2013

Before the meeting started it was noted that Russ Covitt, a long-time friend of several members of the ARM had passed away this morning.

#### Old Business:

Meeting Minutes from December: Published and distributed in Run 8 sent via e-mail.  
Approved as Published.

#### Treasurer's Report: Treasurer's Report for December:

Noted one big item is outstanding – our insurance: At the moment we have a potential liability of \$3,295 for our insurance. Treasurer's Report was Approved as Read.

Concerning our insurance, President Roth has been in contact with our insurance company investigating ways to reduce our insurance cost. The quote received from our current insurance company was approximately \$1,000 more than it was last year. President Roth had started chasing the insurance by calling the company that has carried our insurance policy these last few years, and at first they tried to explain the increase in premium was due to automatic increases in our building and contents coverage by approximately \$9,000 each, but ultimately they reported there had been significant increases in property insurance rates across the State of Texas and this was the bigger culprit behind the increase. Visiting with our insurance carrier, they identified another company offering a

lower rate. The initial quote from this company was still significantly higher than what we paid last year, but it was a few hundred dollars less than what our current carrier had quoted. It appears we may be able to lower this preliminary quote as it lists the value of our building as \$450,000. Last year our building was insured for around \$160,000 thus we don't know where the \$450,000 value came from. Our insurance carrier is to get back with President Roth with information on this. The insurance is due on January 18.

#### Car Sales Report/Update:

Jerry Michels provided a summary of car sales during this past year and noted that sales during 2012 were poor. We had a net profit of \$1,662 which was the lowest amount in several years. Also we have not had any report from Texas Western since Summer. 2009 was our last really good year but that was when we brought in our ART reefers. Sales have been dropping since then and a part of this is the economy and also the fact we don't have any fresh inventory. The value of our current inventory is approximately \$35,000

#### Layout Construction:

Progress: Bench work was extended from Panhandle around the next corner into Cuyler. Tracy continued the installation of spline roadbed into Panhandle and has wrapped the curve around Cuyler with spline extending into Kingsmill now. The work on the spline has essentially caught-up with the bench work thus we need to press on with the bench work. David Jusiak has been laying track and now has a switch (turn-out) he can install to continue the outside main line on through the crossovers. Tracy Ball noted he has cut rail and has parts ready to build 4 more turn-outs. Tracy also reported he had cut more spline material earlier today so he has enough to round the curve at the end of the peninsula from Kingsmill going to Pampa. Virgil Doyle has continued work toward the construction of the turn-out control panels for the Zita and Amarillo Junior Yard areas.

Virgil Doyle mentioned an idea to help overcome the difficulty to wire-in the toggle switches and the switch motors at the turnouts because they are all double-pole, double-throw toggles and the wires coming out of them have to be crisscrossed to power the frog on the turn-out. The idea is to look into having small PC boards fabricated that would have the crisscross in the board and one would only need to solder the toggle switches into the PC boards. Question was raised how much this might cost; the cost is unknown at this time, but Virgil is working on this. Virgil noted a board to accomplish this installation would make it a lot easier to install the switch motors and toggle switches and significantly speed-up the installation. If this can be done, it might be possible to sell some of these boards and help recoup our costs for developing the boards. Paths could be installed on the boards to drive LED indicator lights on the control panels. Virgil is working to figure this out drawing a schematic diagram for these boards but there are difficulties figuring-out which way the toggle needs to be installed and which way the LEDs would need to be installed so they work properly.

#### Phillip Pratt Memorial Garden Railroad:

No work on the railroad these last few weeks due to the weather. President Roth reported he had planted one small area in the garden with a number of acorns and pecans.

#### Building & Grounds Update:

Mowing and weed-eating is still required. Tracy reported he completed some mowing after he had repaired the mower. He even had done some mowing after it had snowed.

TV antenna: Last month we decided to set a date to fetch the pole and track materials from Tracy's place. (This will hold-up installation of an ATCS antenna at the ARM.)

Heating System: Last month it was broken and we were operating the heating system manually. President Roth noted he had ordered and obtained two valve actuators (not motorized) which were installed on Saturday, 12/22. The heating system has been working great since the installation of the new valve actuators was completed. Pictures of the new actuators were published in last month's Run 8.

Small Water Heater: The small water heater feeding the sinks in the kitchen and lavatories had started leaking and it was also replaced last month.

#### News of Other Organizations:

Santa Fe Museum: No recent news.

RAPS: Newsletter issued January 1. They are celebrating their 10<sup>th</sup> anniversary this year.

NMSLRHS: They continue working on restoration of ATSF 2926 in Albuquerque. They expect this to be a big year as they will be getting real close at the end of the year to having the 2926 ready to run.

Recent/Current Promotions: No new promotions.

Rock Island Stuff: Guy Pigg wasn't present to talk about the Rock Island memorabilia.

Donation from Don Dean: No new information this past month.

Railroading Merit Badge: President Roth is set-up to give a class at the Boy Scout Merit Badge University on Saturday, 1/26 tentatively at 3:00 PM and will need to leave here early that day to go teach the class.

Cub Scout Visit: No further news. A Cub Scout Den Leader had asked about possibly having a brief historical presentation and then assistance to work on a diorama; date was not set as they want to do this after weather restricts outdoor activities. David Jusiak felt it would probably be later this month.

Housekeeping Schedule: The months of January, November and December are still open.

#### New Business:

Membership: Need to focus on growth of our membership. A brief discussion was held concerning status of members that dropped their membership during recent months.

Thank You Cards: President Roth showed-off thank you cards he had received from the kids in the afterschool program at Western Plateau Elementary School following his program on the significance of the railroads back on December 7. One card was from the kindergarten and first grade group, and the other was from the second, third, fourth and fifth grades. The cards had been signed by all of the kids and their teachers and will be posted on the bulletin board.

No other new business at this time. Main focus of President Roth has been on the insurance for the ARM and preparation for the Railroading Merit Badge.

Member Leonard Opedenhoff asked if anyone could identify a location in a drawing and passed the drawing around.

Jerry Michels asked if anyone had heard of a digital magazine called *Model Railroad Hobbyist*. Its free. He noted one could go to modelrailroadhobbyist.com or mrh.com or just type-in model railroad hobbyist and it will find it for you. Jerry noted it is an all-digital magazine that is only on the web, but one of its freedoms being on the web is that if someone has an article i.e. on a structure that runs 20 pages, they publish the full 20 pages. He also noted they have some really nice articles. Issues are approximately 20 megs and are easy and quick to download. Jerry stated he felt the articles are more in-depth. They do have advertising, some of which he did not believe was in *Model Railroader*.

Clinics: No long-term schedule for clinics at the moment and tonight we do not have a clinic scheduled.

ARM Work Dates: January 12  
January 26  
February 9  
February 23

Next Business Meeting: Scheduled Date is Thursday, February 7.

Meeting Adjourned.

---

### **Future Events:**

Jan. 26, 2013	Boy Scout Merit Badge University – Railroading Merit Badge
May 29-June 2, 2013	Lone Star Region (NMRA) Convention in Dallas-Fort Worth Sheraton Dallas-Fort Worth Hotel
June 6-9, 2013	“Rails along the Rio Grande” hosted by Rio Grande Division #6, Rocky Mountain Region, NMRA. Albuquerque Marriott Pyramid North
July 31-Aug 4, 2013	Santa Fe Railway Historical & Modeling Society Convention in Flagstaff, Arizona

---

## Cleaning Schedule for 2012 / 2013:

January	
February	Tracy Ball
March	Jim Shook
April	Jim Shook
May	Jim Shook
June	Jim Shook
July	Jim Shook
August	Jim Shook
September	Jim Shook
October	Jim Shook
November	
December	

---

Recent Photographs:      First few photos reflect a great work day at the ARM.



Pampa side of peninsula: Saturday, January 12, David Jusiak and Joe Sweeny move boards out of the way from around the base of the bulletin board. Clean-up effort was started an hour earlier.



At the same time as the wood was being relocated on the Pampa side of the peninsula, Tracy Ball was working on joists on the opposite side of the peninsula at the location for Kingsmill.



A short while later the bulletin board had been relocated and the floor was swept to make ready for bench work. Before the end of this work day the bulletin board had to be relocated a second time.





View following the end of the work day on Saturday, January 26. Joists have been installed down the full length of Pampa and the next step will be to start on the adjoining side.



This is the end of the peninsula with the bench work now fully extended from Amarillo Junior Yard all the way thru Pampa as it stood at the end of the January 26 work day.



First leg of the spline sub-roadbed extending down the length of Kingsmill. Cuyler is located at the far end and Panhandle is on the opposite side of the aisle. This was the status of construction on the layout at the end of the day on January 26, 2013.



# Run 8

March, 2013

## President's Message

*By Bob Roth*

Let me apologize for being so late in issuing this month's issue of Run 8. I will admit that for once, I have had plenty of time to work on it as I have been off from work for a while, but I did not feel like working on it while I was under the influence of pain medications that affected my judgment and made me so tired that I spent more time sleeping and resting than anything else. For anyone that is not aware, I had surgery during mid February to relieve a problem and I have been off-work for a while to recuperate. This has affected my weekly attendance at the ARM following my surgery, but hopefully I will be "back in the saddle" soon.

While I was involved with my own recovery I received a message that member Joe Bolt is having serious health problems and he was moved into a care center on February 12. Please keep Joe and his family in your thoughts and prayers.

I did manage to make it out to the ARM on Saturday, February 23 but I was in no condition to do any work; my main objective was to take a few photos for Run 8. I found I was able to do much more as we had two of the Scouts from the Railroading Merit Badge class I taught last month out at the ARM to work on a requirement to visit a railroad museum and to report on what they saw and learned. David Jusiak was giving the Scouts and their moms a tour when I arrived and I greeted them when they came back into the Meeting Room. One of the Scouts left but the second Scout had a lot of questions and we ultimately spent some quality time sitting down going thru some of the merit badge requirements that were not covered in the class. At least this was a job I could do sitting down...

Out around the ARM work continued on the HO scale layout inside while the weather still was not conducive for work on the garden railroad or on any other tasks outdoors and significant progress continued. On Saturday, February 9, we were able to build the bench work on the flat wall stretch between Pampa and Miami (across the aisle from Zita) and then without my assistance, folks were able to build the bench work halfway up the wall thru Miami and also install both the corners thus connecting the bench work from Pampa with Miami. This leaves only the stretch with one corner to connect Miami with Canadian and thus complete the lower level bench work. Along with this bench work, Tracy has continued with installation of spline sub-roadbed around the end of the peninsula from Kingsmill into Pampa and given my lack of attendance, I am not sure where this stands. David has also been following a distance behind working on installation of cork roadbed and track. I also observed Guy Pigg working on soldering power drop leads from the track which is also needed. Given

recent progress it appears that our intermediate goal of completing the lower level is getting close within reach.

Next Meeting: The next Business Meeting will be on Thursday, March 7 at 7:30 PM. As I write this there is no planned clinic following the meeting.

Bob Roth

---

## MEETING MINUTES

### ARM Business Meeting

February 7, 2013

#### Old Business:

Meeting Minutes from January: Published and distributed in Run 8 sent via e-mail.  
Approved as Published.

Treasurer's Report: Treasurer's Report for January: Approved as Read.

Insurance: Concerning the one large outstanding liability reported by Treasurer Virgil Doyle, President Roth worked with our insurance carrier, and another company was identified that quoted a lower rate of approximately \$2,700 for the ARM after some back and forth effort to correct some information. This is still a significant increase over what we paid for insurance last year, but the increase is approximately half what had been initially quoted.

#### Car Sales Report/Update:

Jerry Michels had sent a report by e-mail last night; he stated sales picked-up a bit in January, nothing spectacular, and nothing new to report. We had one pretty good size order tonight. Orders are almost all coming thru our website. We are about the same place as we were last year at this point. Last month the Board had discussed possibly looking at a new run of cars, Jerry had not started work on this and he hopes to get some ideas going this month. Jerry stated he heard Intermountain is looking at a new run of Autoracks with etched brass sides; the quoted price will be around \$80 per car.

#### Layout Construction:

Progress: Director Tracy Ball stated he hoped everyone could see some improvement. Bench work is completed all the way thru Pampa and we are fixing to head around the corner. Spline is completed up to Kingsmill. Cuyler is done. We still have a couple of sidings to complete in Panhandle but we have enough now for 2 main lines and a passing siding over there. We'll have 2 sidings and 2 main lines thru Kingsmill within a couple of weeks and he has laid-out the line going around the corner into Pampa. This weekend on the work-day hopefully we will work on the bench work heading around from Pampa toward Miami. Subroadbed is coming along behind the spline. 600 feet of track (2 boxes) have been on order for the last seven months and we are still waiting to receive this track; we will still need another 3 boxes of track (if anyone wants to donate a box). Jerry Michels stated that Walthers is showing track as being available on their website with a sale advertised at \$8.00 per stick; this is Shinohara track. List price for Walthers track is \$8.80 per stick. We are using Atlas track on our layout.

## Phillip Pratt Memorial Garden Railroad:

No work on the railroad this past month due to the weather. Director Tracy Ball noted as the weather warms up we will get back to work across the street. We still have to finish our conduit by the front door.

## Building & Grounds Update:

The lawnmower is running; mowing and weed-eating is still required.

TV antenna on the West end of the building tore-loose from the building and is laying on the ground needing to be re-installed.

ATCS Antenna: Need to set a date to fetch the pole and track materials from Tracy's.

Wall Protection: President Roth had investigated this and found a clear sealer at Sherwin-Williams store on Coulter. Cost is approx. \$18 per quart or \$47 for a gallon. They only have Gloss or satin finish. He has not checked with any other paint stores such as Devoe Paint. Tracy Ball stated roughly 10 gallons will be required; this is how much blue paint was used on the walls. Hopefully it won't take as much of the clear sealer.

## News of Other Organizations:

Santa Fe Museum: No recent news.

RAPS: Newsletter issued January 1. Celebrating their 10<sup>th</sup> anniversary this year.

NMSLRHS: They continue working on restoration of ATSF 2926.

Director Guy Pigg noted he had observed an article in the Amarillo Independent (the Indy) where the Railroad Artifact Preservation Society is talking about having a Mall where the Madam Queen is the center. Guy noted it was in their paper last week and one might need to go look in their archives on their website. President Roth noted he had heard about this last year but had not brought it up as he was waiting for further development. The place is to be called Queens Crossing. Last word, they are trying to figure out how to finance it. Part of it would be a Museum with the Madam Queen as the centerpiece and they want to be connected to track so they can take the Madam Queen out for excursions if BNSF will allow it. A question was asked if they can raise all the money for the asbestos abatement; asbestos abatement services for the restoration of the Madam Queen are already donated to occur. Insurance will be an issue with excursions too. Concerning Queens Crossing, a bunch of small shops planned along with the Museum. They have a financing plan and now they have to work to raise the funds. The question is where they will site it.

Recent/Current Promotions: Flyers were put out at the hobby shops to advertise tonight's clinic..

Rock Island Stuff: Director Guy Pigg stated he had not been able to get in touch with Mrs. Crites and has left a number of messages thus he figured this is probably a no-go on trying to get her to donate her dad's Conductor's uniform to the Museum.

Railroading Merit Badge: President Roth gave a class at Boy Scout's Merit Badge University on Saturday, 1/26 with a total of 34 Scouts in attendance. Someone noted they had seen President Roth on the TV. President Roth stated the Scout Executive that lead the TV camera person around reported the video person told him they learned a lot in the time they were in the room

with his presentation. There was only a 2-hour time frame thus President Roth noted he only was going over background information and they only covered approximately half the Merit Badge requirements in this class; they had more work to do if they want to finish the Merit Badge. The kids asked a lot of questions which showed they were interested.

**Cub Scout Visit:** David Jusiak reported he would give the Den Leader's phone number to President Roth as they are looking at a presentation and tour in March.

**Housekeeping Schedule:** Tracy Ball was on the schedule this month; President Roth had vacuumed the other day to help. November and December are still open.

### New Business:

**Priorities:** The Board met briefly on Thursday, 1/10 and discussed our priorities. Membership is one priority where we need to work on growth. Discussion that modelers want to run their trains thus the feeling of the Board that we need to get the layout running and this might help in attracting new members. Priority will be given to completion of bench work on the lower level and then the track so that we have a complete run from the Staging Yard to Amarillo Junior Yard.

We are loaded with projects right now including the layout, the garden and a lot of little fix-it projects. The Board does not want to take-on any more projects at this time.

**Power Pole:** The Board plans to wait until Spring to get the pole from Tracy's. We can't count on the weather right now. This is another project.

Guy Pigg asked about the outfit from Sayre on the ATCS monitor. President Roth noted he had not had any recent communications with those folks. Guy noted he is on the group list and while he is not getting any feedback from there, surprisingly, him being a ham radio operator, he received a brief message about 3 weeks ago from a guy in OKC stating they need a monitoring site here in Amarillo. On a side note Guy stated he has been looking into DSL out here (at the ARM). The company is working on getting higher speed on their network; cost will be around \$30 per month no matter what seed we get. Guy stated he would recommend we go with a higher speed with voice-over internet protocol. President Roth stated he will leave this issue to the Board. There is still some time before we make any commitments.

**Make-A-Wish:** We received a call from Make-A-Wish; they have a young client that would like a model railroad. President Roth visited with a representative from Make-A-Wish on Saturday, 1/26 and discussed issues with a model railroad before he ran to Canyon for the Merit Badge class. The discussion was that a model railroad is not something that just magically appears – poof – instant railroad. He told her the first thing is the design, one needs to know the space available. She had no clue. Showing-off the ARM layout, President Roth noted we hired the design and now we are working the design to build it; this is a project. He noted we are overcommitted at the moment with everything that is on our plate. The issue was left if anyone wants to help with this effort to give her a call. A question was asked concerning what they want, a layout on a 4x8 sheet of plywood or something more; the lady with Make-a-Wish could not give this to us. President Roth told her as a starting point we would need a diagram of the room and what type of layout they want, one that is against a wall, our one that is out in the center of the room that a person can walk around. Guy Pigg noted the T-track concept they saw at the train show in Oklahoma City would work good; he recommended the layout be built

in N-scale. The kid is approximately 11 years old and apparently his dad has an HO scale locomotive of some type that he would like to put on the layout and be able to play with it. Guy noted the T-track is a modular concept that should fit most anywhere. Supposedly they have a room in their house where they would put this layout.

**Hot Air Balloons:** Beverly Lyle noted that back when Virgil Young was in the hospital she went to see him. Virgil Doyle came later and visited at the same time; they had a discussion that Virgil Young wanted to see some more hot air balloons on the layout. This was a surprise to President Roth. There was already one hot air balloon painted on the backdrop. Beverly stated she had found some newspaper clippings from 2009 when hot air balloons were in the area. It was suggested she hang onto the clippings for future reference. Virgil Doyle noted she was more than welcome to put some on.

**Clinics:** No long-term schedule for clinics at the moment, tonight Michael Chavez will talk about some of his experiences riding the “White Train.”

**ARM Work Dates:** February 9  
February 23  
March 9  
March 23

**Next Business Meeting:** Scheduled Date is Thursday, March 7.

Meeting Adjourned.

---

**Future Events:**

April 1, 2013	(Monday 7:00 PM) Cub Scout Group Tour
May 29-June 2, 2013	Lone Star Region (NMRA) Convention in Dallas-Fort Worth Sheraton Dallas-Fort Worth Hotel
June 6-9, 2013	“Rails along the Rio Grande” hosted by Rio Grande Division #6, Rocky Mountain Region, NMRA. Albuquerque Marriott Pyramid North
July 31-Aug 4, 2013	Santa Fe Railway Historical & Modeling Society Convention in Flagstaff, Arizona

---

## Cleaning Schedule for 2012 / 2013:

January	
February	Tracy Ball
March	Jim Shook
April	Jim Shook
May	Jim Shook
June	Jim Shook
July	Jim Shook
August	Jim Shook
September	Jim Shook
October	Jim Shook
November	
December	

---

## Recent Photographs:



2/23/2013: North side of layout along the North wall looking toward the new bench work at Miami from the corner by the West end of Canadian. More stuff needs to be relocated to keep this aisle open.





Bench work around the East end of the layout between Pampa around the corner at the far end of this bench and Miami to the right. Tracy Ball is working on the far corner. Note the use of the spline strip to achieve the smooth rounded corner.



Virgil Doyle, Tracy Ball and Guy Pig working to fill-in the corner of the bench work off the East end of Pampa.



Virgil Doyle trimming-off the end of the top piece on a custom-built segment of L-girder.



Spline sub-roadbed extending down the length of Kingsmill encompassing two main lines and sidings on both the North and South sides of the main lines. The core of the spline for the North main is wrapping the end of the peninsula extending East from Kingsmill toward Pampa in this photo.



# Run 8

April, 2013

## President's Message

*By Bob Roth*

As the month of March comes to a close I would like to wish everyone a Happy Easter.

Although I was sidelined the first half of the month of March, I was kept busy with other activities and was not able to use my time-off from work to do any model railroading. One of those activities included picking-up a bunch of record documents and carting them out to the ARM.

Earlier during the month of March we received an e-mail message from Dan Dauner, son of Francis Dauner. Francis had been Secretary for the Texas Panhandle Railroad Historical Society (TPRHS) several years ago and as that organization retrenched, she wound-up with a number of documents from the Santa Fe Railroad the Society had managed to capture. All these documents had been saved in a few steel file cabinets and in a number of pressboard banker's boxes and all these documents were stored outdoors under the cover of the porch in front of her home. Francis passed-away back in October and her family is looking to settle the estate thus all the railroad stuff needed to be removed from the property so it can be sold.

I initially made a trip out to the house to survey the records and found there were a total of seven steel file cabinets, some with documents in them and some that were empty, and a number of the banker's boxes and a few additional boxes with paper in them stacked on top of the file cabinets with no protection. The banker's boxes were in pretty rough condition however the paper inside them was still in good shape. Looking at the volume of the material, it did not look like a substantial quantity of paper, but we currently have a problem with a lack of storage space out at the ARM and we still need to figure-out where it can be placed. Ideally a box car or (retired) refrigerator car would work great for storage of these records plus some of the other stuff inside the building, but the trick is to find something we can afford. While going out to the Dauner's on one of my trips I noticed a long former ice-bunker reefer in a field along FM-1541 (South Washington Street) just North of the old Claude Highway that had a for sale sign on it. I stopped by on my way back and looked at the reefer and felt it would meet our needs and I was hopeful it might be an orphan needing a new home that could be donated to the ARM. Unfortunately when I called the number that was on the for sale sign I found-out the particular reefer had been sold, but a few others on that property were still for sale at a price of \$2,500 plus another \$1,500 (each) to move them, but none for donation. Those old reefers make good storage buildings thus there is some demand for them and it is extremely doubtful we could get one

donated for that reason. From the Museum perspective it would be nice to have an ice bunker reefer for display.

I investigated some other reefers at other locations and found they too were for sale for the same \$2,500 price thus I gave-up on the reefer for now. After this I called Progress Rail Services and asked if they might have any box cars that are to be scrapped and was told they have a few BN box cars thus I contacted BNSF and I am waiting to hear back. The issue would then be relocation of the box car from Progress to the ARM and unfortunately we do not have the funds available in our bank account to move them at this time.

Relative to the issue of storage space at the ARM, with the lower level bench work extending along the North side of the layout, all the stuff stored along the North wall needed to be moved to open the aisle. The priority at the ARM on Saturday, March 23 was to move the stuff that was stored along the North wall inside the Train Room out to the storage container and this was accomplished primarily in the morning with the time remaining in the afternoon spent working on the bench work at Canadian extending it toward the corner and with this we are rapidly approaching another significant milestone in the construction of the layout. A comment from David Jusiak was the “rough grading” (on the lower level) is nearly complete.

With the weather warming-up we need to resume work outside on the Phillip Pratt Memorial Garden Layout. The short segment of concrete roadbed that I laid late last year held-up very well with the freeze and thaw cycles over the course of the winter thus I plan to resume work on the roadbed if I can tolerate the activity. (I am still recovering from foot surgery.)

News Tidbits:

Model Railroad Track: Code 83 track has been out of stock in hobby shops around the country for several months due to the manufacturer’s changing plants where the track was made. Recently suppliers started received shipments of track and of course there has been a significant increase in price. We have been using ATLAS Code 83 track on the layout and it has finally been received by a number of suppliers. Jerry Michels sent an e-mail message stating he had bought 50 sticks and challenged other members to match him.

Albuquerque NMRA Convention: We received two notices from Al Hovey concerning the “Rails Along the Rio Grande” Mountain Region National Model Railroad Association convention to be held in Albuquerque June 6-9. The one notice related that all of the pre-convention operating sessions were filled. I downloaded two of the attachments sent concerning the convention and they are attached to this newsletter but there was a page that I was unable to download that states 23 layouts including N Scale, HO, HO<sub>N3</sub>, O, Sn3 and G scale will be available for viewing as one of the convention activities.

Lone Star Region NMRA Convention: This year’s convention will be held in Irving, Texas May 29 – June 2. Information states that clinics will have an emphasis on operation from beginner to expert.

Elections: May is the month in which we hold elections. This year we elect three (3) Directors to our Executive Board for a 2-year term. Currently these Director’s positions are held by Jerry Michels, Tracy Ball and Guy Pigg. If any of our members are interested in running for one of these positions, please let me know.

Next Meeting: The next Business Meeting will be on Thursday, April 4 at 7:30 PM. As I write this there is no planned clinic following the meeting.

---

## MEETING MINUTES

**ARM Business Meeting**

March 7, 2013

Old Business:

Meeting Minutes from February: Published and distributed in Run 8 sent via e-mail.  
Approved as Published.

Treasurer's Report: Treasurer's Report for February: Approved as Read.

Insurance: Bill was received and paid.

One bill is pending to pay the Missouri Pacific Historical Society their portion of profits on ART cars to-date.

Car Sales Report/Update:

Car sales have been real slow so far this year; we have made only \$239 in profits so far this year on gross sales of \$736.

The Board had suggested looking into a new run of custom cars and Jerry has been getting with contacts. Jerry stated he had talked with Intermountain about re-doing the very first version of the ART reefer as we have had a lot of people asking about it since it sold-out; this car sold very quickly after it came-out. This was the car with just the ART shield on the side. These cars ran from 1938 until 1950 and later; that is when they started being repainted with the 3 heralds for ART, Wabash and Missouri Pacific. Information from Intermountain stated they can process an order for a new custom run, but there are some new requirements. The minimum order is 300 pieces. The order has to be processed in parallel with Intermountain's production orders for the same model with different "decorations;" the factory no longer accepts orders for 300 pieces. Intermountain will probably will not run the ART model until early 2014. Currently they are running the R40-23 reefers and then they are running the R40-25 reefers. The price currently is less than a dollar more than our last run and it will be a little bit more in 2014 with anticipated factory increases this year. Cars will be manufactured by a different factory as Intermountain has moved their production to a new factory. There may not be a sample to check, probably just a photo from the factory; turn-around from the factory for checking the photos is 24-36 hours. They are only doing decorated fully-assembled models. That is a full year out thus Jerry asked about doing a different car... Further discussion pertaining to specific ideas omitted from the minutes. The main thing is we are looking at ideas and we want one that will sell quickly to replenish our coffers.

PRR X29 Boxcars: Sales thru the Texas Western Club in Fort Worth.

Layout Construction:

Progress: Significant progress continued this past month as bench work was extended from around the East end of Pampa and started up thru Miami leaving only the segment from Canadian to Miami to complete the lower level bench work. Tracy continued the installation of the spline roadbed in Kingsmill and had started to string it around the end of the peninsula into

Pampa. Additionally more roadbed and track were laid, and more power drops were soldered to the track. This is as-of Saturday, 2/23.

#### Phillip Pratt Memorial Garden Railroad:

No work on the railroad this past month due to the weather on our scheduled work days.

#### Building & Grounds Update:

Good moisture was received from the snow from the blizzard Feb. 24-25. Tracy reported we had a lot of snow around the ARM.

Mowing and weed-eating is still required.

TV antenna on the West end of the building tore-loose from the building and is laying on the ground needing to be re-installed.

ATCS Antenna: Need to set a date to fetch the pole and track materials from Tracy's.

#### News of Other Organizations:

Santa Fe Museum: No recent news.

RAPS: No recent news.

NMSLRHS: They continue working on restoration of ATSF 2926 in Albuquerque.

Recent/Current Promotions: No new promotions.

Rock Island Stuff: Contact with the lady looking to sell her Dad's Rock Island Conductor's Uniform and other items.

Donation from Don Dean: No new information this past month.

Railroading Merit Badge: Two Boy Scouts visited the ARM on Saturday, 2/23 to complete one of their requirements to visit a Museum. President Roth worked with one of those Scouts to go over several of the other requirements for the badge.

Cub Scout Visit: Talked with the leader of this group on Tuesday, 3/05 and scheduled a special appointment for them to come out to the ARM on Monday, April 1 at 7:00 PM. Plan is to give a brief presentation on the significance of the railroads and a tour of the ARM.

E-mail message received from an Amarillo College student (Ashley Overeynder) with an assignment to write a paper about a form of art at a museum and she would like to use the ARM.

Housekeeping Schedule: March was Jim Shook although we haven't seen him yet. The months of November and December are still open.

#### New Business:

Estate Sale: We received an e-mail message earlier this week with a flyer concerning a sale of model railroad equipment this weekend. The sale is for the estate of William L. (Bill) Page and the sale is in Abilene.

TPRHS Documents: We received an e-mail message from the family of Francis Dauner; she passed away back in October and a lot of documents from the TPRHS were stored out on the porch of

the home. The family is working to settle the estate. President Roth went and looked on Tuesday, 3/04, and observed there are a total of 7 steel file cabinets, only some of which contain documents, and a number of the cardboard banker's boxes setting on top of the file cabinets. The document file boxes are all water-damaged, but the contents appear to be in good condition. There is a wide variety of documents in these files. President Roth noted he had picked-up the banker's boxes earlier before this meeting and they were sitting out in the bed of his truck outside and he requested some help to carry these boxes inside following the meeting.

Museum Guide: President Roth noted this had been discussed with Tracy a while back about the need for a guide to the ARM. This has been a need for some time so that anyone giving a tour can have the correct information at their fingertips.

Daylight Savings Time: Time change is this Saturday evening March 9.

Jerry noted that Don Dean had visited on Saturday, 2/23.

Member Joe Bolt was having severe health problems and was moved into a care center per message received by President Roth.

Clinics: No long-term schedule for clinics at the moment.

ARM Work Dates: March 9  
March 23  
April 13  
April 27

Next Business Meeting: Scheduled Date is Thursday, April 4.

Meeting Adjourned.

---

### **Future Events:**

April 1, 2013	(Monday 7:00 PM) Cub Scout Group Tour
April 4, 2013	ARM Business Meeting
May 2, 2013	ARM Business Meeting; Election of Directors
May 29-June 2, 2013	Lone Star Region (NMRA) Convention in Dallas-Fort Worth Sheraton Dallas-Fort Worth Hotel
June 6-9, 2013	"Rails along the Rio Grande" hosted by Rio Grande Division #6, Rocky Mountain Region, NMRA. Albuquerque Marriott Pyramid North
July 31-Aug 4, 2013	Santa Fe Railway Historical & Modeling Society Convention in Flagstaff, Arizona

---

Cleaning Schedule for 2012 / 2013:

January	
February	Tracy Ball
March	Jim Shook
April	Jim Shook
May	Jim Shook
June	Jim Shook
July	Jim Shook
August	Jim Shook
September	Jim Shook
October	Jim Shook
November	
December	

---

Recent Photographs:



3/23/2013: North side of layout along the North wall looking at the new bench work at Miami from the corner by the West end of Canadian. Note stuff along the wall was relocated to clear this aisle.





L-girder at Canadian is being extended toward the curve at the Northwest corner of the layout between Canadian and Miami. Work paused for a moment so Tracy Ball, Jerry Michels and Virgil Doyle could look toward the camera.



L-girder around the Northwest corner of the layout as it stood at the end of the work day on 3/23. The lowered L-girder in this area is to accommodate modeling of the Red Deer Creek area between Canadian and Miami.



3/23/1013: Virgil Doyle and Jerry Michels working on installation of joists at Canadian after work on L-girder was halted.



# NEWS RELEASE

## Pelle Søeborg EVENT SCHEDULE



**Thursday, June 6th / 7pm & 9pm / Kokopelli Room**

**CLINIC - Rebuilding a Model Railroad from A-Z**

**Friday, June 7th / 8am / Kokopelli Room**

**CLINIC - Done in a Day Weathering & Details**

**Friday, June 7th / 9-11am / Pavilion**

**CLINIC - Weather & Mingle Sessions**

**Saturday, June 8th / 8am / Ballroom**

**BOOK SIGNING - at Train Show**

**Saturday, June 8th / 6pm / Kokopelli Room**

**FEATURED SPEAKER - Banquet**

**ALBUQUERQUE MARRIOTT PYRAMID NORTH**

**Register and make your reservations now at**

**[www.rarg2013.org](http://www.rarg2013.org)**



# NEWS RELEASE

# TIME'S RUNNING OUT!

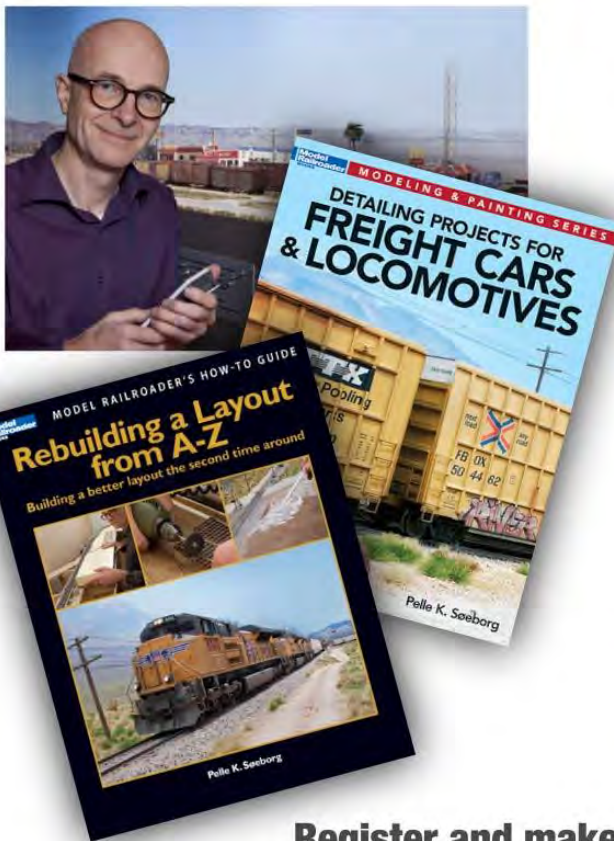

**You only have 'til April 15th to order your copy of Pelle Sæberg's latest books and have the noted modeler personalize and autograph them especially for you!**

**Visit [rarg2013.org/extra-fare](http://rarg2013.org/extra-fare) to order yours today!**

**Watch for Pelle to be featured on the cover of the July issue of 'Model Railroader' - his 10th prestigious cover! Meet and learn from Pelle at Rails Along the Rio Grande 2013!**

**Register and make your reservations now at [www.rarg2013.org](http://www.rarg2013.org)**



# Run 8

May, 2013

## President's Message

*By Bob Roth*

National Train Day: National Train Day is Saturday, May 11. Those attending the April Business Meeting are aware that I received a message from Sam Teague, President of the Railroad Artifact Preservation Society in the week prior to our April Business Meeting relating they are planning to host an "official" National Train Day event at the Madam Queen downtown and asked if we might be interested in participating. Since we need to promote the ARM in the local community this is an event we need to participate in and the members present agreed. During the April Business Meeting we discussed setting-up a table at the Madam Queen where we can hand-out flyers for the ARM which might lead to a number of folks coming out to the ARM, but we did not have a firm plan for activity at the ARM. We do want to be able to run model trains to show-off what we are working toward and I am hopeful we can get the outer loop of the garden running too. This date falls on one of our scheduled Saturday work days thus I hope we can get more of our members to come out on this day to assist in hosting the visitors that may come out to the ARM on that date.

For anyone not familiar with National Train Day, AMTRAK started the idea of National Train Day in 2008 as a promotional effort to promote the railroads and of course train travel; the majority of the promotional events are held at cities served by AMTRAK, but the National Train Day event has grown each year and events are being hosted in some cities that do not have AMTRAK service. The date selected for the National Train Day celebration is set on the Saturday closest to May 10 in recognition of the date in 1869 when the golden spike was driven in Promontory, Utah signifying completion of this nation's first transcontinental railroad. Behind this event was the passage of the Pacific Railway Act by congress which was signed into law by President Abraham Lincoln on July 1, 1862 that called for construction of a railroad and a telegraph line across the continent to connect the state of California with the rest of the nation.

It was interesting to think that last year the Union Pacific Railroad was celebrating their 150<sup>th</sup> anniversary which coincided with the passage of the Pacific Railway Act and how much the railroad has changed over the years from their beginning. I started to get more thoughts for a railroad time-line I want to develop for display at the ARM. In looking at the NMRA calendar I noticed that a number of historical events significant to railroads occurred in the April-May timeframe over the years; here is a sampling:

April 13, 1846

The Pennsylvania Railroad was chartered.

April 23, 1866	Westinghouse patents the first air brake for railroad equipment
May 10, 1869	The first transcontinental railroad was completed
April 29, 1873	Eli Janney patented the knuckle coupler
April 30, 1900	Casey Jones rides into eternity
April 18, 1934	The Burlington Zephyr was dedicated
May 26, 1934	CB&Q Pioneer Zephyr runs non-stop Denver to Chicago
May 1, 1971	AMTRAK started operation of passenger trains
April 1, 1976	Conrail was formed consolidating several bankrupt railroads

The railroads keep evolving...

When I give tours to visitors at the ARM there are a couple questions in particular that are usually asked: When do you expect to finish the model railroad? How long have you been working on the layout? The first question is difficult to answer because progress is dependent upon how many “hands” that show up that can assist on any given Thursday evening and on our Saturday work days; we don’t get much done when we only have four of us working out there and with Spring the grass and weeds have started growing and our chores are increasing with the need to mow and weed-eat around the grounds of the ARM. I started thinking on this second question and I have not researched the answer, but I realized that we are at the 10-year mark since we broke ground for the building at the ARM. I will do this research later in the year as I will look to verify when we officially moved-out of Western Plaza; we want to get the lower level operating before we reach this date.

News Tidbits:

Elections: Don’t forget elections for Directors at our May Business Meeting. Currently these Director’s positions are held by Jerry Michels, Tracy Ball and Guy Pigg and no one else has indicated any interest in running for one of these positions. If any of our members are interested in running for one of these positions, please let me know.

Next Meeting: The next Business Meeting is scheduled on Thursday, June 6 at 7:30 PM. Personally speaking I have a conflict with this date. As I write this there is no planned clinic following the meeting.

**1st ANNUAL NATIONAL TRAIN DAY CELEBRATION**  
**Open House , Food , Music & Tours**  
 Saturday May 11th 9am to 5pm  
 Sponsored By:

Logos include: PAK-USA, AmaDazzle, Santa Fe, 5000 FIFTY HUNDRED TEAM, Coca-Cola, Amarillo College Jazz Ensemble, City of Amarillo, Amarillo Ice Co., Townsquare Media, Teague Construction, Joe Daddy's, and the 5000 FIFTY HUNDRED TEAM logo with 'HOST' text.

## MEETING MINUTES

### ARM Business Meeting

April 4, 2013

#### Old Business:

Meeting Minutes from March: Published and distributed in Run 8 sent via e-mail.  
Approved as Published.

Treasurer's Report: Treasurer's Report for March: Approved as Read.

Car Sales Report/Update: Director Jerry Michels was absent; no report available.

#### Layout Construction:

Progress: Tracy Ball reported he had the turn-outs all planned for the East end of Pampa so he can get them laid-out and continue with the spline roadbed around to Miami. L-girder is now complete around the corner and lacks only installation of some joists to complete the lower level bench work excluding the fascia and spline roadbed. Tracy reported he had started the turn-around for the wye at Panhandle; it is not ready to go yet. Guy Pigg noted he had been installing drops and had questions on the crossovers thus had skipped-over them and continued on installing the drops further ahead; he was caught-up with the track laid by David Jusiak. Tracy noted the need to get with the Layout Committee to discuss the location of crossovers. It was noted the Layout Committee is currently consists of Tracy and President Roth; Tracy wanted more folks in on the discussion concerning the location of crossovers so that operations can be considered. Tracy wants to drop-back and look more closely at Panhandle and Kingsmill and get all the crossovers in. Tracy reported he had completed five more turn-outs today and had brought them out; four No. 6's and 1 No. 8. Tracy noted he had also repaired the one crossing (for the FW&D) that had been damaged; this crossing had been reinstalled and looked good to the folks that had observed it. Tracy also reported he had installed the curved turn-out at the West end of Zita. Guy noted he needed a little direction for wiring drops at the crossings.

#### Phillip Pratt Memorial Garden Railroad:

No work on the railroad this past month due to the weather on our scheduled work days. We probably could have worked on it some the last Saturday work day before the winds got up, but everyone was busy moving stuff to clear the aisle space inside the building. Tracy will try to bring-out his cement mixer so we can resume work.

#### Building & Grounds Update:

Mowing and weed-eating is still required.

TV antenna on the West end of the building tore-loose from the building and is laying on the ground needing to be re-installed.

ATCS Antenna: Need to set a date to fetch the pole and track materials from Tracy's. We have a lot on our plate at the moment

#### News of Other Organizations:

Santa Fe Museum: No recent news.

RAPS: No recent news. President Roth noted RAPS sent-out their newsletter on April 1; it did not contain very much in the way of news. Approximately half the newsletter concerned "how they did it" as the bell from the Madam Queen was restored with several photos. There was also a description of plans for the Queens Crossing development.

NMSLRHS: They continue working on restoration of ATSF 2926. Their recent news concerned casting a part to replace one that had been stolen last year.

Recent/Current Promotions: No new promotions last month. See new business for a new opportunity.

Rock Island Stuff: President Roth asked Guy Pigg if this item should be dropped off the agenda list. Guy related the son was more interested in the value of the stuff and it is assumed that he has sold or will try to sell the items; E-Bay works for most stuff.

Donation from Don Dean: Don Dean visited before our last meeting but we had not heard anything since then.

Cub Scout Visit: Cub Scouts from Pack 82 visited the ARM on Monday, April 1 at 7:00 PM. President Roth gave them a briefing on the railroad equipment at the ARM prior to tour, then a presentation on the significance of the railroads and ended with a tour of the layout. President Roth noted we should look at putting a cover over the seat in the locomotive after the scouts made a comment about the holes in the foam on the seat.

Museum Guide: President Roth noted he had worked on draft guide to the ARM. This has been a need for some time so that anyone giving a tour can have the correct information at their fingertips.

TPRHS Documents: President Roth made several trips out to the Dauner home during the past month first retrieving documents in boxes, then documents and other items from the file cabinets and finally bringing the 4 good file cabinets out to the ARM. The file cabinets are temporarily stored under the eave behind the ARM building where the 3 modules had been stored while the deteriorated modules were scrapped. President Roth had sent an e-mail message to Jeff Ford back on March 9 with a number of questions concerning the TPRHS materials and a message was received back from Jeff Ford last night responding to those questions. Specific questions: Table cloth and napkin Jeff stated were from the Texas Zephyr and were from his personal collection but we could display them in our glass display case; they had been missing for a long time and he was glad they had turned-up. Jeff had noted we could display the table cloth and napkin in our display case if we want. Jeff noted a large portion of the documents came from the ATSF Building & Bridge Department in Amarillo and were donated by the BNSF approximately 10 years ago; if the ARM is not interested in them, Jeff recommended they be forwarded to the archives at the railroad museum in Temple. The one issue is how to get the documents to Temple; we don't want to pay to ship them. Tracy noted he goes to Coleman on a somewhat regular basis and he could take the records to Coleman if someone could meet him to transfer the records.

There were questions concerning the Temple Railroad Museum and the archives and President Roth attempted to answer those questions; one of the questions concerned the make-up of the archives and the scanning of documents. President Roth noted the Santa Fe Railway Historical & Modeling Society receives and has received several collections of documents, plans and photographs from various sources over the years and for this reason they set-up their archives



to house the documents. The Society has their Western Archives set-up in California and a the Museum at Temple houses their second archive location. The Society has members appointed to help oversee the archives. The archives are open to folks that want to do research; it just requires one to make an appointment. Relative to the TPRHS records, the discussion was the archives will be the place for these records. Tracy noted some of the records concern various structures and an individual file on a building will have information including the color of paint they used to the glass replaced and the building being shot-up and needing repair; its the whole story of a building from the beginning until they got rid of the building. We want to mine these records for information pertinent to structures on our layout and scan them before we send them off. President Roth has contacts with the Society and the archives and can contact them. President Roth noted we need to go thru the records and make an inventory of all the files.

Concerning the Temple Museum, President Roth noted he had taken video inside the Museum as he made a very quick tour of the Museum last year and he needs to download this video onto a DVD; they have very nice displays set-up in the Museum.

As for the TPRHS, Jeff Ford noted the organization had ceased to function approximately 5 years ago and at that time they had emptied their storage container and its contents had been dispersed or disposed of; he did not have a clue where everything went to. So far as he knew their bank account had been emptied and donated to charity. Financial records found should be destroyed as recommended to Jeff by President Roth in his e-mail message.

**Reefers For Sale:** After picking-up all the TPRHS records President Roth had a concern over our lack of storage space. He had observed a nice 50+ foot long ice bunker reefer on a lot along Washington just to the North of the Claude Highway with a "For Sale" sign on; he called the number and found it was McDowell House Moving; the particular reefer was sold, but other 40-foot reefers were available and these reefers were priced at \$2500 plus another \$1500 to move them. He also had checked the scrap yard along I-40 since they had a set of reefers out front along I-40 and found the reefers out front were in use, but they indicated they had more reefers in back they would sell for \$2500 which would cost additional to move. Given our current financial posture we are not in position to purchase something like this. A call was made to Progress Rail Services that found they may have a few BN box cars that are to be scrapped and a request was then sent to BNSF via e-mail for donation of a box car.

**Housekeeping Schedule:** President Roth vacuumed and did some cleaning in preparation for the visit by the Cub Scouts on April 1. The restrooms were not cleaned.

### New Business:

This month marks our 10<sup>th</sup> anniversary since we started construction of the building. President Roth noted when giving tours of the ARM he is frequently asked when the layout will be finished and how long we've been working on the layout. Taking this backwards, the realization is that we broke ground on the building in April, 2003, ten years ago. We started with the construction of an empty shell, finished the interior ourselves, and today the developing layout occupies the majority of the space. We are so close to achieving our original goal...

**National Train Day:** We received an invitation from Sam Teague with the Railroad Artifact Preservation Society to participate in the first National Train Day celebration to be held here in Amarillo. AMTRAK initiated National Train Day to promote railroads and railroad travel. Sam indicated he had signed-up with the national organization to host an "official" National

Train Day event here in Amarillo. Planning is still in preliminary stages and they are planning for music and food. Catering is tentatively to be provided by Joe Daddy's. They are working on advertising and obtaining a proclamation from the city council. They anticipate being open at the Madam Queen from 10:00 AM – 4:00 PM. This falls on our first scheduled work day in May and it would provide an opportunity for promotion of the ARM to the general public with a chance we could probably draw people from there to come out to the ARM that day. It would not cost us anything. We would need to provide our own table and chairs and a cover (for shade) is recommended and display (brochures). We do need to promote the ARM... We have a month to play with this.

The question was posed to the membership present how folks felt about participating. The question was asked if we could sell anything; yes. The suggestion was made that we could sell some hats. It was noted that we don't have a banner; we probably need a banner with the ARM logo. A 6-foot long banner was recommended to fit on a 6-foot long table. It was suggested we could put together a book with photos from around the ARM to show-off. There was a question what we can do out here at the ARM for show and the one thought was to cut-off the pins that stick-up at several of the turn-outs so that we can operate from the top of the helix down the main line thru Junior Yard. With a little more work that would involve connecting power drops to the track we might be able to operate as far as Panhandle. If people see we have a chunk of the layout up and running it would be a big plus and a few folks might be enticed to join the ARM.

**Donation:** We received a donation of some model railroad equipment and buildings. We had been contacted by a lady that lives in Colorado Springs; her mom lives in Borger and her dad had passed away a while ago leaving behind his model railroad. They had family members take what they wanted and she wanted the rest to go somewhere. President Roth had informed her about the Make-A-Wish project and she was ok with this. Another thought with some of the buildings is that although they won't fit in the scheme of our layout, they could serve as temporary place-holders for particular businesses.

**Elections:** At our May Business Meeting we will hold elections for 3 Directors. Currently these positions are held by Tracy Ball, Jerry Michels and Guy Pigg. If anyone else is interested in running for one of these positions, please let President Roth know.

**Clinics:** There is no clinic planned this evening and there is no long-term schedule for clinics at the moment.

**ARM Work Dates:** April 13  
April 27  
May 11 – National Train Day  
May 25 – Memorial Day weekend

**Next Business Meeting:** Scheduled Date is Thursday, May 2.

Meeting Adjourned.

---

**Future Events:**

May 2, 2013	ARM Business Meeting; Election of Directors
May 11, 2013	National Train Day
May 29-June 2, 2013	Lone Star Region (NMRA) Convention in Dallas-Fort Worth Sheraton Dallas-Fort Worth Hotel
June 6, 2013	ARM Business Meeting
June 6-9, 2013	“Rails along the Rio Grande” hosted by Rio Grande Division #6, Rocky Mountain Region, NMRA. Albuquerque Marriott Pyramid North
July 31-Aug 4, 2013	Santa Fe Railway Historical & Modeling Society Convention in Flagstaff, Arizona

---

**Cleaning Schedule for 2012 / 2013:**

January	
February	Tracy Ball
March	Jim Shook
April	Jim Shook
May	Jim Shook
June	Jim Shook
July	Jim Shook
August	Jim Shook
September	Jim Shook
October	Jim Shook
November	
December	

---

**Recent Photographs:**



Northwest corner of layout located between Canadian (to the right) and Miami (to the left). What a difference a couple of weeks can make from the photos provided last month. Note the lowered joists around the corner will allow for modeling the Red Deer Creek area.



East end of Pampa: Spline ends at plywood for location of turnouts where tracks will be reduced to only a single main track heading East (bottom of photo).



Kingsmill: Left photo shows the East end of Kingsmill with cork roadbed laid on the spline. Right photo shows the West end of Kingsmill where recent track-laying is evident. Track is laid on the spur that serves the elevator at Cuyler at the upper left side of this photo.



The President's Inspection Train: Trains can now travel from the top of the helix (after the track on the helix is cleaned) thru Zita and on to the far end of Amarillo Junior Yard. Train is sitting at the (railroad) West end of Zita behind the curved turn-out. (Pardon all the junk in this photo.)



Preparations in the Phillip Pratt Memorial garden to install the track roadbed on the North side of the garden.



# Run 8

June, 2013

## President's Message

*By Bob Roth*

I believe and will declare that National Train Day on Saturday, May 11 was a success for the ARM; although we did not have a "crowd" of visitors that day, we seemed to have a steady number of visitors. We had two members staffing a table at the site of the Madame Queen passing-out flyers to the folks that showed-up downtown in an effort to encourage people to come out to the ARM and it appeared to be successful as the visitors showed-up at the Museum throughout the day. I want to thank everyone that came out and helped on this date including student member Cory Gabel as he ran trains on a piece of the layout between the helix and Junior Yard. I am sure this effort was somewhat frustrating at the time as we had track problems in the middle of this stretch to fix with a derailment hazard on Main 1 and dead spots between the crossover turn-outs on Main 2, both located at Zita. I was also able to get a short stretch of the garden railroad running along the front edge of the garden on this day where the track had been bolted together by running an extension cord across the street and connecting a power pack to the track. In the least, we were able to show-off what we are working toward to all those folks that visited.

I found-out more about the track problems myself in the week following National Train Day after we were contacted by folks from Channel 4 asking if they could schedule an appointment to visit the ARM. At first we thought this would provide some brief coverage on the news, but instead they were looking for a feature for a program showing weekdays at 4:00 PM called Studio 4. I took the time to dig-out several of the passenger car models I have been acquiring over the last several years and I made an effort to assemble a mid-1960's consist of the San Francisco Chief behind my A-B-A set of PAs. Initially I set this train up on Main 1 aimed westbound and this was how I found-out about the track problems. Running westbound from the Amarillo depot area the PA's would not traverse over the first turn-out at Zita without splitting the switch. After straightening-out the locomotives, I found that some of the following cars also derailed on that turn-out. I then attempted to run this train on Main 2 aimed eastbound and while I was able to back the train up the helix and run it back down, the train broke apart coming thru Zita particularly as parts of the train crossed assorted turn-outs with additional problems incurred due to dead spots in the track between the turn-outs that caused the locomotives to stall. I gave-up on this effort and returned the train to Main 1 aimed westbound again to simulate the train leaving the Amarillo Depot area. I will admit this was not the best way to demonstrate a train on the layout by breaking cardinal rule #1 as all the cars were essentially straight out of the boxes and as-of yet I have not gone thru the cars making-up this train to check the coupler heights and the weight of the individual cars against the standards; I could tell that some of the

Walthers cars were light and I could see a few coupler mismatches but the train looked real good sitting on the track and I could run it up to the bad turn-out. In the end I was missing five cars from a typical mid-1960's consist, particularly two storage mail (baggage) cars on the front end of the train, the diner that went behind the dome car, and two sleepers that ran near the tail end of the train. I have a lot of work ahead of me to finish this train...

Concerning the appointment by Channel 4, they came out in the afternoon on Thursday, May 23 and spent approximately an hour with myself, Jerry Michels and Tracy Ball. The show featuring the ARM was scheduled to air on the Studio 4 program on Channel 4 on Wednesday, May 29.

Phillip Pratt Memorial Garden Railroad: Out in the garden I was hopeful we could run a train in the garden for National Train Day thus I connected a power pack to the track in the front and found (after some effort cleaning track) that we can shuttle a train back and forth on the portion of the track that is bolted together along the front of the garden. I quickly found the power did not transmit beyond a joint just around the southeast corner of the garden that was not bolted and that is where the train stopped. Looking at that joint in the track, I could see dirt down in the track joint connector and I remembered a friend had recommended application of conductive grease in all the track joints just in case we wanted to try to utilize track power. Ultimately the plan is to utilize battery power on the G-scale trains out in the garden so that we don't have to fight problems with dirty track but first we need to evaluate the various battery-powered control systems that are available. As an interim move we will pull an extension cord across the road to apply power to the track. I continued working on the road bed during the month and I also found that we need to obtain more pieces of straight track to complete the outer loop to replace some of the bent and broken track that was donated to the ARM.

Member News: Member news during the month of May was the one negative spot for the ARM. On May 6, member Joe Bolt passed away. I missed this news due to all the time I was spending working on preparations for National Train Day and I didn't catch the news until a week after the fact. On Saturday, May 11, member Jim Shook came by and turned-in his key; his health deteriorated over the winter and Jim can no longer be out at the ARM by himself. The third strike came a few days later when we received news that Virgil Young has been placed in home hospice; the news is that he can appreciate an occasional visitor at this time.

Next Meeting: The next Business Meeting would be scheduled on Thursday, July 4 but given this is Independence Day the Business Meeting will be deferred until Thursday, July 11 at 7:30 PM. As I write this there is no planned clinic following the meeting.

In looking at the NMRA calendar I noticed that a number of historical events significant to railroads occurred in the April-May timeframe over the years; here is a sampling:

June 6, 1919	The Canadian National Railways were incorporated.
June 19, 1964	The Bay Area Rapid Transit system began construction.
June 21, 2001	The heaviest train ever was operated in Australia.
June 30, 1977	Last regular Railway Post Office (RPO) service in US ended.

---



## MEETING MINUTES

### ARM Business Meeting

May 2, 2013

#### Old Business:

Meeting Minutes from April: Published and distributed in Run 8 sent via e-mail.  
Approved as Published.

Treasurer's Report: Treasurer's Report for April: Approved as Read.

Car Sales Report/Update: Jerry Michels gone this month; No updated information on car sales.

#### Layout Construction:

Progress: Bench work around the lower level is no complete except for fascia and spline roadbed. Sidings in Pampa were started. Tracy has worked on laying-out the spline for the main line from Pampa toward Miami plus the Clinton, Oklahoma & Western (CO&W) line that ran from Pampa to Clinton, Oklahoma. Additionally more roadbed and track were laid, and more power drops were soldered to the track. Tracy was working on several turn-outs. Tracy had checked on track earlier today and it is now supposed to be at the Amarillo Hobby House around the end of this month. David Jusiak noted that glue is needed. Tracy noted we needed about 3 sheets of plywood and that our supply of poplar is getting low thus we need to order some more. Jerry had received an e-mail message indicating that Virgil and Paula were offering to make a donation to pay for some materials. Further discussion concerned other material needs including wire.

#### Phillip Pratt Memorial Garden Railroad:

President Roth noted he had pulled weeds and had worked on preparation of the roadbed to lay more concrete. We will attempt to power the track with regular power for National Train Day with the issue being to get power across the street. Prefer not to run an extension cord across the street that could be damaged by traffic, but that appears to be our option. David Jusiak noted an article in the latest issue of Garden Railroading Magazine concerning batteries for garden trains. Some of the batteries guys were using in their locomotives had blown-up and/or caught fire because they were either overcharged, undercharged, or charged too many times. These were lithium-ion batteries. The article recommended a lithium-ion potassium battery that can be recharged 3,000 plus cycles.

#### Building & Grounds Update:

Mowing and weed-eating is still required.

The fire extinguishers had been recertified for another year and we added two new fire extinguishers.

TV antenna on the West end of the building tore-loose from the building and is laying on the ground needing to be re-installed.

ATCS Antenna: Need to set a date to fetch the pole and track materials from Tracy's.

#### News of Other Organizations:

Santa Fe Museum: No recent news.

RAPS: RAPS will host National Train Day downtown. They have a number of sponsors lined-up and plan to have music all-day with different groups coming out; one group should be the Amarillo College Jazz Ensemble. More under New Business.

NMSLRHS: They are preparing to host National Train Day and plan to move the tender for the ATSF 2926 downtown where it will be hooked to an AMTRAK locomotive; they have a steam whistle mounted to the tender and they will have an air compressor set-up so they can blow the steam whistle. They want to keep people in Albuquerque excited about the restoration of the steam engine.

Recent/Current Promotions: No new promotions. See New Business.

Museum Guide: President Roth noted no further work this past month on the draft guide to the ARM as he had been a little preoccupied.

#### New Business:

Elections: We are supposed to have elections this month for 3 Directors. Currently these positions are held by Tracy Ball, Jerry Michels and Guy Pigg. No one had approached President Roth concerning a desire to serve a term as a Director. Motion made by Guy Pigg that the three current Directors be re-elected by acclamation. Motion was seconded by David Jusiak and the motion was approved.

National Train Day: President Roth had been in contact with Sam Teague recently; the National Train Day website shows their hours they will be open from 9-5 that day. Last month he had been told the hours would be from 10-4; the 9-5 hours are what is posted out there and Sam had indicated they plan to be there during those hours. They have public service announcements (PSA's) running on 5 (Town Square Media) radio stations. The Amarillo City Commission is scheduled to issue a proclamation on Tuesday, May 7. There was a story on Channel 10 aired last Sunday, 4/28. Sam had related they had a 96 year old man celebrating his birthday that had been an engineer on the Madame Queen many years ago and Channel 10 had come out to catch his story; while Channel 10 was there they had started asking questions about National Train Day and wound-up doing a story on National Train Day too. Sam had reported the 96 year old man had climbed right up in the cab and had a lot of stories to tell about experiences.

Guy and Liz were supposed to check on a banner; Guy stated the logo was going to cost a lot of money. Question was raised whom they had talked to; Tracy noted that FastSigns had our logo on file. Guy stated the logo would take a lot of ink and all the colors. Tracy noted the place on the Canyon E-way also has our logo – AutoTrim, but it had been a long time since we had talked with them; they might have lost it by now. President Roth noted he had thought about what to put on a banner; the thought was for the banner to be 6-feet in length where it could be put on the front of a 6-foot long table and it should have the name “Amarillo Railroad Museum” spelled-out at the top, the address 3160 I Avenue... Guy stated this would add to the cost; we will be talking about something that will cost \$100, \$200, \$300. Guy stated the logo will be expensive enough; he felt the other information with the address and website is on our flyers. The time factor is the big concern at the moment. The one question was how much money we wanted to spend. Treasurer Virgil Doyle stated zero. Tracy suggested taking the sign off the front of the building. Further discussion concerned not spending our funds for a

banner that will have limited use. Sam had asked if we had anything to give away as door prizes; we could give away some of our hats. Virgil Doyle offered some old used model train equipment.

Booth at the Madame Queen: President Roth noted he has a pop-up canopy that can be used to provide shade. We need to take a table and some chairs. What else? Brochures. Hats. We can try to sell our hats there. Do we want to take any of our cars to try to sell? Discussion that the folks at the Madame Queen would not be interested in our custom models and it was not recommended. Do we have anything else to give-away? Idea suggested that if people buy our hats and wear them out here we could give them something. Magazines – we have a bunch of duplicate copies of magazines we can give away. The one concern was that the will could be a problem thus we don't want to take a bunch of stuff out to the Madame Queen. Guy and Leonard had volunteered to staff the booth at the Madame Queen. Desire will be to try to sign-up new members.

Further discussion followed on visitors to the ARM. We have had a lot of visitors from outside this area; last week we had a gentleman from New York and another from Virginia visit. Tracy noted that recent visitors are more excited about the model railroad now than visitors just 3 months ago.

Refreshments? Tracy noted our Coke machine had died.

Carol Abraham will talk with Chip Chandler to try to get something in the Get Out section of the newspaper.

Clinics: No long-term schedule for clinics at the moment.

ARM Work Dates: May 11 – National Train Day  
May 25 – Memorial Day weekend  
June 8  
June 22

Next Business Meeting: Scheduled Date is Thursday, June 6. President Roth noted he has a personal conflict on that date...

Meeting Adjourned.

---

### **Future Events:**

June 6, 2013	ARM Business Meeting
June 6-9, 2013	“Rails along the Rio Grande” hosted by Rio Grande Division #6, Rocky Mountain Region, NMRA. Albuquerque Marriott Pyramid North
July 31-Aug 4, 2013	Santa Fe Railway Historical & Modeling Society Convention in Flagstaff, Arizona

---

Cleaning Schedule for 2012 / 2013:

January	
February	Tracy Ball
March	
April	
May	
June	
July	
August	
September	
October	
November	
December	

---

Recent Photographs:



Model of the San Francisco Chief circa the mid-1960's by Bob Roth. This train is short 5 cars from the typical consist of the era including 2 storage mail (baggage) cars that would have been near the front end of the train, the diner which followed the big dome car, and 2 sleepers that would have been near the tail end of the train.



The difference one week can make: This is the wall between Pampa (around the far corner) and Miami (around the near corner). Spline at the upper far left-hand side of this photo represents the Clinton Oklahoma & Western (CO&W) branch line as it extends from Pampa and starts dipping down as it heads toward our hidden chase. The other set of spline represents the single main track between Pampa and Miami.



Corner at the East end of Pampa: Spline in the foreground is the CO&W while the spline in the background is the main line as it extends toward Miami.



Amarillo Junior Yard: Tracy Ball's set of FT's pulling mixed freight on Main 2 while Tracy's GP7 is pulling a set of hoppers for Producer's Grain.



One of the trains in the Phillip Pratt Memorial Garden: Train was able to run back and forth on the track along the South side of the garden using track power. Work is continuing on construction of the roadbed for the outer loop around the garden.



Freshly laid roadbed on the North side of the Phillip Pratt Memorial Garden to support the track. Next step will be installing the track on the roadbed after the roadbed is extended further.

## Obituaries

### Joseph M. Bolt

 Joseph M. Bolt, 78 of Amarillo died Monday, May 6, 2013.

Memorial services will be at 3 p.m. Thursday in Schooler Funeral Home Brentwood Chapel with the Rev. Bill Wade officiating. Arrangements are by Schooler Funeral Home, 4100 S. Georgia St.

Joseph was born Jan. 27, 1935, in Kansas City, Mo., to Joe and Mary Ellen Bolt. He grew up in Needles, Calif., and served two years in the Army. He then graduated from Cameron College in Lawton, Okla., where he met the love of his life, Sharron Cummings. They were married on Dec. 13, 1959, in Lawton.

Joseph served 29 years in the Army Reserves and retired as a Sergeant Major. He was employed by the U.S. Postal Service, retiring as postmaster in Fletcher, Okla., after 28 years. Joseph enjoyed Westerns, was an avid model railroad enthusiast and dearly loved his pets.

He volunteered many years with Oklahoma Medical Research Foundation, participating in their trial studies. Joseph also served many years on the board of directors of Comanche County



**Joseph M. Bolt: 1935-2013**

Federal Credit Union.

He was preceded in death by his parents, and a sister, Betty O'Hara.

Survivors include his wife, Sharron; three daughters, Aletha Bolt and Joe Bussey, of Oklahoma City, Teresa Floyd and husband Mark of Lawton and Cindy Baeza and husband Jr. of Amarillo; a brother, Richard Bolt and wife Helen of Kingman, Ariz.; nine grandchildren; and four great-grandchildren.

The family suggests memorials be to Oklahoma Medical Research Foundation, 825 N.E. 13th St., Oklahoma City, OK 73104, or at OMRF.org.

Sign the online guest book at [www.schoolerfuneralhome.com](http://www.schoolerfuneralhome.com).

Amarillo Globe-News, May 8, 2013



Cactus starting to bloom outside in the garden at the end of May.





# Run 8

July, 2013

## President's Message

*By Bob Roth*

The month of June zoomed past me and I am trying to put this newsletter together while the month of July is already speeding by. That is what happens when one is slightly busy...

The last couple of weeks at the end of June my wife and I took some time-off to visit with our folks in other parts of the country but we are back now and trying to get back into the swing of things. Due to our vacation I missed the visit by the Model A car club that visited the ARM on Saturday, June 22. Unfortunately for me this was the second time this group has visited the ARM while I have been off travelling elsewhere; maybe I can be here the next time their group decides to come out to the ARM.

Since I've been gone recently I cannot say much about work completed around the ARM lately but I have observed that Virgil Doyle has continued working on the installation of Tortoise switch motors with the associated wiring of switches and LED indicators in temporary control panels at Zita. Tracy also built a new custom turnout and replaced the one turnout at the East (or North) end of Zita where my PAs could not pass without derailling. We looked at this particular turnout early in June and observed problems with its construction where one rail had been filed down too narrow where the points were supposed to close (but would not close), one of the points had also been filed down too far and its end was bent, and a guardrail by the frog was too close to the stock rail thus nothing could really run thru this turnout without a high probability for derailling. Now that the new turnout has been installed I will have to give it a try.

Relative to the layout, I also spent a couple of hours earlier in the month visiting with Virgil Young and we spent time going thru some of the inventory of buildings he built over the years. Virgil assembled a significant collection of structures a number of which directly apply to the ARM layout including the Hereford depot, Crowe-Gulde's plant in Hereford, Rockwell Brothers Lumbermen also from Hereford, depots for Black, Friona, Kingsmill and Texico, the Black Mercantile, the Black water treatment facility, a coal shed (Virgil mentioned there was one in Black up until the 1950's), a motor car shed, a manager's house, and a bunch of telephone booths to scatter around the layout. In addition to all of these structures Virgil has a whole bunch of other structures that could go almost anywhere around the layout including houses, miscellaneous businesses, outhouses, signal enclosures and more. Unfortunately we were unable to go thru the complete inventory of buildings before Virgil ran out of steam and had to rest. Hopefully we can continue this effort at another time.

Phillip Pratt Memorial Garden Railroad: Out in the garden I managed to lay another section of roadbed around the West side of the garden on a Thursday evening but I will admit that it was dark before I was finished and I want to thank the Tracy and David for assisting me in trying to get this section done that evening. It takes a lot of work to prepare a section for roadbed – pulling weeds, compacting the soil, laying weed block fabric while fighting the wind and then laying-out the track to locate the roadbed. I also spent a bit of time online searching for G-scale straight track and I placed an order for enough straight track to finish the outer loop and start the second loop. The next order of business for the garden after the straight track is received will be to install the track on the completed roadbed around the North and West sides of the garden while I continue the work on the roadbed around the South and East sides of the garden and hopefully get the outer loop completed within the next couple of months. I just can't predict how long this will take given the need for a lot of other work to pull the forest of weeds that have sprouted in the garden bed, weed-eat the weeds and tall grass that have sprouted up around the perimeter of the garden (and other places) and probably to do some mowing to beat-back the grass and weed growth from the rains incurred earlier in June.

Outside of the ARM, the biggest news is that most of the railroad equipment belonging to the Museum of the American Railroad (formerly the Age of Steam Museum) has been moved from Fair Park in Dallas to their new home in Frisco with the move of Frisco steam locomotive #4501 from Dallas to Frisco on May 26. The Big Boy and an F-unit painted in the Santa Fe's red and silver warbonnet scheme are the last pieces that remain at the old location in Fair Park with a planned move date for these two locomotives around July 14 "if traffic on the rails is slow enough to permit the 55 mile creep from Dallas Fair Park" according to an article in the most recent issue of *Cowcatcher Magazine*. There are also a number of cautions noted discouraging people from going out to watch this event as the railroads and property owners along the route do not want people trespassing on their property and there are no recommended places where one might be able to watch this move.

In looking at the NMRA calendar only two particular historical events significant to railroads occurred in during the month of July as follows:

July 4, 1828	The first stone was laid for the Baltimore & Ohio Railroad. (This was the nation's first chartered common carrier railroad.)
July 7, 1862	The US Congress passed the Pacific Railway Act.

Next Meeting: The next Business Meeting would be scheduled on Thursday, August 1 at 7:30 PM unless we decide to postpone it a week given the late date for the July Business Meeting. As I write this there is no planned clinic following the meeting.

---

## MEETING MINUTES

### ARM Business Meeting

June 6, 2013

Member News: Tracy had talked with Paula about Virgil Young. Tracy had also spoken with Earl Carrell and found that he had gone back to work but his routes had been changed-up and he gets home late; he is working around the home on projects during the weekends and has gotten out of the habit of coming out to the ARM.

### Old Business:

Meeting Minutes from May: Minutes had been published in Run 8 however the publication had not been distributed due to an error in not attaching the latest issue of Run 8 to the transmittal e-mail, thus approval of the Minutes will be held until July. President Roth will resend the transmittal with Run 8 within the next couple of days.

Treasurer's Report: Treasurer Virgil Doyle was absent thus there was no Treasurer's Report; this will be presented at the July Business Meeting too.

Car Sales Report/Update:

Jerry Michels reported we received 90 of the PRR X29 Boxcars back from the Texas Western Club in Fort Worth. Their Chief Operating Officer, Kathy something included a letter in the box essentially saying "We are returning these cars, thanks for the opportunity to work with you." Jerry is attempting to get in touch with her to get some kind of explanation why they are sending these cars back but he has not heard anything back yet. Jerry noted they don't list any of their officer's e-mail addresses on their website. These cars have been stowed away...

We had a few sales during the past month.

New Car: There was some discussion concerning use of our line of credit to launch a new run of custom cars; we have a number of options to consider and need to make a decision soon. Information on specific potential car projects omitted from these minutes. Particular issues affecting car choices are that factories in China no longer want to do small runs; they only want to do large runs of cars thus we would need to pick a car type that a manufacturer is doing in another scheme. Also, Intermountain is no longer producing kits, only built car models.

Layout Construction:

Progress: Tracy noted he had been gluing boards together. Some wiring had been done, and switch panels were being assembled. Jerry had been working on the PM-4 short circuit detectors. Some roadbed and track had been installed and decking for Panhandle was ready to install. As soon as that decking is installed the track installation can proceed beyond Panhandle. Tracy noted he still has one more siding to install at Kingsmill and he had completed the CO&W to the wall. Tracy still has a small yard to install at Pampa. Tracy had picked-up plywood today and the poplar is in but Tracy had been unable to make the connection to pick it up. Tracy had also been in contact with Amarillo Hobby House and the box of track is still on order.

Phillip Pratt Memorial Garden Railroad:

President Roth noted he had done some more work in the garden this past month. Roadbed had been laid around the Northwest corner and West side of the garden was leveled and ready for extension of the roadbed. He also noted a lot of the straight track that had been donated was busted and bent and he has been searching for straight track. We had measured the length of track required the week before this meeting and determined we lacked approximately 19-feet of straight track. A good sale was found and four more remote control turn-outs were ordered. There was some discussion concerning new track – basically we are looking for long pieces and we can cut them where required to fit specific spots. David had gone to the hobby shops

this past weekend and found they are not ordering any new stock as G-scale is not selling very well and there have been significant price increases. Short pieces of track were priced at approximately \$8.00 per foot.

#### Building & Grounds Update:

Mowing and weed-eating is still required. We had a good rail out here during the hailstorm on Tuesday evening; Highland Park school nearby reported approximately 0.8 inches of rain from this storm. This rain will give the grass and weeds a boost...

TV antenna on the West end of the building tore-loose from the building and is laying on the ground needing to be re-installed.

ATCS Antenna: Need to set a date to fetch the pole and track materials from Tracy's.

News of Other Organizations: Relatively quiet following National Train Day.

Santa Fe Museum: No recent news.

RAPS: No recent news.

NMSLRHS: They continue working on restoration of ATSF 2926.

Recent/Current Promotions: We had approximately 3½ minutes shown on Channel 4 in their program "Studio 4" on Wednesday, May 29. President Roth noted he had recorded the program on the DVR at home but in watching it, some of the information was covered-up with weather warnings. The folks at Channel 4 sent us a link to the video and it was clear of all the weather warnings. President Roth had hoped to download it onto a DVD, but it appeared this may be nearly impossible to do; he will send the link to the news story with Run 8 when he resends it.

Museum Guide: No further work on draft guide to the ARM this month due to other projects and priorities.

Housekeeping Schedule: Jim Shook turned-in his key last month on National Train Day due to deterioration of his health to a point where he can no longer be out here by himself; we need to revisit the housekeeping schedule since Jim had signed-up to do much of the housekeeping thru the summer and fall.

#### New Business:

Article in Newspaper on Sunday, May 26 concerning the possible re-routing of the Southwest Chief thru Amarillo. This is to be seen if this AMRTAK train is actually rerouted. Jerry noted there was an article in *Trains* magazine. Fred Frailey did an article concerning "10 Train Rides That You Want to Take Now" which included the Southwest Chief as one of the trains. It notes that BNSF claims the upgrades to run the Southwest Chief over the route thru Amarillo will cost almost as much as the upgrades required to the line the Southwest Chief currently operates on that goes over Raton Pass. The states of Texas, Oklahoma and Kansas do not want to provide any state subsidies to run the Chief thus it is unknown what will happen in 2015 when the current operating agreement expires. It will run for the next 2 years. This generated a lengthy discussion concerning the operation of the railroads.

Bricks: Jerry Michels had a small panel to show-off with some of the face bricks mounted for display; the idea is this display would be a way to show-off the bricks as they are a way to raise money. This display could be made longer and could be mounted in front of the

building or on posts out by the garden. We need to evaluate the best location; we want them outdoors where people driving by might be able to see them.

Model News: Walthers announced they are coming out with a consist for the San Francisco Chief.

Clinics: No long-term schedule for clinics at the moment.

ARM Work Dates: June 8 (this Saturday)  
June 22  
July 13  
July 27

Next Business Meeting: Scheduled Date is Thursday, July 4 but since July 4 is Independence Day, we will defer the business Meeting until the following week, July 11.

Meeting Adjourned.

---

**Future Events:**

July 11, 2013                      ARM Business Meeting

August 1, 2013                      Tentative: ARM Business Meeting

July 31-Aug 4, 2013                      Santa Fe Railway Historical & Modeling Society Convention in Flagstaff, Arizona

---

**Cleaning Schedule for 2012 / 2013:**

January	
February	Tracy Ball
March	
April	
May	
June	
July	
August	
September	
October	

November	
December	

## Recent Photographs:



Brick Display developed by Jerry Michels to show-off examples of bricks that people could purchase.



New custom-built turnout fabricated and installed by Tracy Ball at (railroad) East end of Zita. Note there is a slight curve thru this turnout. A Tortoise switch motor has been installed to operate this turnout.

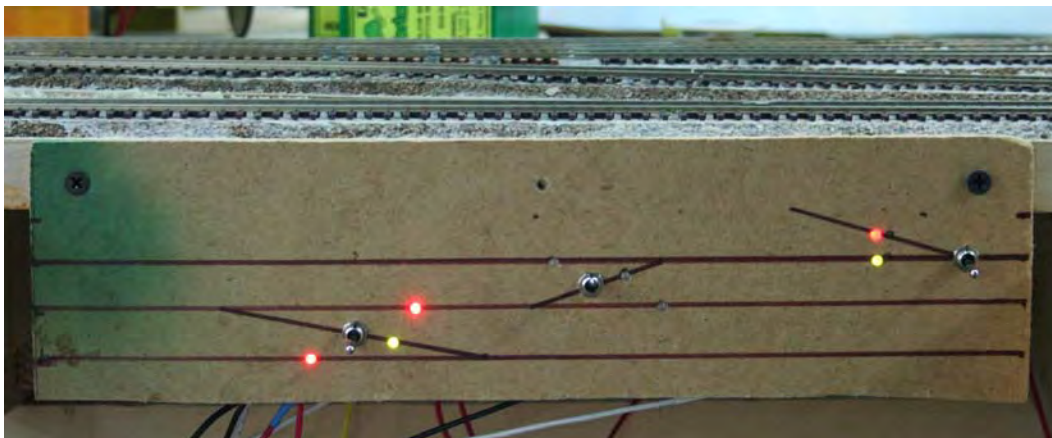

Temporary turnout control panel being installed at Zita with LED indicators for tracks.



The difference a month can make: The photo on the left was taken on June 8 while the photo on the right was taken on July 7. Donated track sections are just laid on top of the roadbed in the photo on the right.



One of the locomotives donated to the ARM garden layout. On June 8, President Roth spent time to pull all of the locomotives outside to take photographs of each one.



A more finished appearance to the garden around the Northwest corner of the garden minus garden plantings. Still much more work to be done...





# Run 8

August, 2013

## President's Message

*By Bob Roth*

On our first work weekend in July, while I saw horrendous weed growth in the Phillip Pratt Memorial Garden, I observed that we had a major problem all-around the ARM as weed growth had taken-off due to the rains received in prior weeks. Given this situation, I spent the majority of the day mowing and running the weed-eater in an effort to beat-back the growth closer to the ARM building and garden. Also, given the heat that day I was forced to take frequent breaks to drink cold water and cool-off, but I still managed to make a significant dent in the immediate area around the building and the garden. In the following two weeks I was able to take time to actually work in the garden and pull the majority of the taller weeds, but unfortunately as I worked to remove the larger, taller weeds I found a couple of large patches of goats heads (stickers) in the garden which exacted a chunk of my time to try to remove these plants without losing too many of the little balls with the sharp stickers in them; we may find-out how successful I was in this process with the growing season next year...

In general, work around the ARM progressed very slowly this past month as many of our active members took some time-off (including myself) thus there is not much news relative to progress on any of our projects in particular to report at this time. On the HO scale layout, Jerry Michels continued working on wiring while Virgil Doyle was attempting to debug problems with a new switch panel and the Tortoise switch motors. David Jusiak laid more track around Panhandle and Kingsmill with turn-out installation being the time-consuming task. Out in the garden, while most of my time and effort went into weed pulling, on Saturday, July 27, I had help from student member Cory Gabel and a friend of his that was staying with him in starting to clean and assemble the track on the concrete roadbed. We still have a long way to go on the track assembly, but at least it was started.

One other task I started to work on this past month was that I started going thru the various files that had belonged to the Texas Panhandle Railway Historical Society (TPRHS). Unfortunately I have not gotten very far with this task. The plan is to give these files to the Santa Fe Railway Historical & Modeling Society to keep in their archives at the Museum in Temple so the records may be available for anyone to research specific features or activity on the Santa Fe Railroad in past years. My goal is primarily to develop an inventory of all the files so that we might be able to scan and thus electronically save copies of any documents pertinent to our HO scale model railroad layout before we transfer all these files to the Society's archives, however this task will take some time to accomplish due to the volume of material in all the file boxes. This task is somewhat complicated by my personal interest in just finding-out what is in these files. Most of the files that I have sifted thru contain

primarily correspondence, letters and teletype messages and lists of materials used to make repairs on various structures while some of the files contain blueprint drawings along with the other documents. I had started filtering thru one open box containing a number of files for cotton platforms and other structures when I ran across one file for a cotton platform in Happy, Texas; a sketch within this folder for retirement of the cotton platform caught my attention and as I looked at this sketch I thought the lettering looked awful familiar which was confirmed when I found my initials on the bottom of this sketch... No wonder the lines and lettering on the sketch had looked familiar to me, but I sure don't remember working on this some thirty years ago.

As I look at the current state of the layout construction I started thinking that we need to set a goal for ourselves to push ourselves to work to achieve that goal. The particular goal I have in mind is to complete the track around the lower level of the layout and have it in a mostly operational state by the month of November. By "mostly operational" the goal would be for the track installation to be complete including the turn-outs for all the sidings and side tracks coming off the main line, with power drops connected from each section of track to be connected to the bus thus providing power to the track. I do not count having all the turn-outs wired although this would be nice to have, given the time that switch motor installation is taking I feel this aspect is unrealistic to complete in this time frame. Why November? I am looking at November being National Model Railroad Month and a good time for us to hold an open house in an effort to attract new members to the ARM. My hope is the outer loop around the garden will also be complete and operational by this time too but I can state this will be a challenge given all the work ahead of us to complete this task and all the other tasks that divert my attention. Let's plan to discuss this during the upcoming Business Meeting.

Next Meeting: The next Business Meeting would be scheduled on Thursday, August 8 at 7:30 PM. As I write this there is no planned clinic following the meeting.

Bob Roth

---

## MEETING MINUTES

### ARM Business Meeting

July 11, 2013

#### Old Business:

Meeting Minutes from May: Published and distributed in Run 8 sent via e-mail.

Approved as Published.

Meeting Minutes from June: Published and distributed in Run 8 sent via e-mail.

Approved as Published.

Treasurer's Report: Treasurer's Report for May: Report not available; Treasurer Doyle had left a copy for President Roth earlier in the month and he did not have it with him this evening.

Treasurer's Report for June: Approved as Read.

Noted we had a donation from Virgil & Paula Young in the amount of about \$870 for plywood and wood.

There was some discussion on membership as we

Car Sales Report/Update:

We had some sales in June and no sales in July yet.

Jerry noted the need for a decision on a new car as we had discussed last month; the question was which car to go forward with. Further discussion on this subject (not published for reasons of confidentiality).

#### Layout Construction:

Progress: Tracy reported they (Jerry Michels and Virgil Doyle) had been working on the switches, wiring for the panels; he had the wood for Panhandle cut-out and we can get it attached; and there has been some laying of rail. There was some discussion on color of wires for various items; black and white wires were being used for track power and black and white had also been used for power for Tortoise switch motors. Green is the common. Yellow is the frog wire. It was recommended that we use red and blue (or another color) to power the switch motors; issue is that we need to keep it consistent. Jerry noted the PM-42's should be in pretty good shape now; he had simplified the wiring. Jerry was working on new connectors for splitting the power that work with 6-pin telephone jacks. Jerry had also picked-up some equipment that uses induction to detect trains; this system will detect locomotives and will require a few cars with resistors on the wheels – we would only need to equip cabooses with resistors on one of the wheels. This system is also supposed to work with signal system and will work with Loconet.

#### Phillip Pratt Memorial Garden Railroad:

Pictures had been placed in Run 8. More concrete roadbed had been placed in June; the one placement ran past 10:00 in the evening the one day. President Roth had placed an order for one box of 12 pieces of 5-foot long straight track; he had looked at the website for AristoCraft Trains, but found the item for approximately \$50 less thru a website for trainz.com. The description of the track was “mint” the description means it is either new or like new and it was in stock; a box had been received at the UPS Store and President Roth had to go pick it up. President Roth noted he had also taken every locomotive we have, and had taken them outside to get pictures of each of them; this gives us a little bit of an inventory and this also gives us an idea of the equipment we have to be equipped with battery power to run in the garden. President Roth questioned which locomotive had belonged to Carol Abraham's son; while several folks noted it was the little green LGB locomotive, President Roth stated there were three (3) little green LGB locomotives; he had been surprised at the number of locomotives that had been donated to the ARM for the garden.

#### Building & Grounds Update:

Mowing and weed-eating is really needed due to rains received in June.

#### News of Other Organizations:

Santa Fe Museum: No recent news.

RAPS: No recent news.

NMSLRHS: They continue working on restoration of ATSF 2926.

Recent/Current Promotions: No new promotions during the month of June.

Museum Guide: No further work on draft guide to the ARM this month due to other projects and priorities.

TPRHS Documents: No change in status this month. President Roth was hoping to complete an inventory of the TPRHS records before contacting the Museum folks; if he is going to get an inventory done he only has a few weeks as he is leaving for Flagstaff for the SFRH&MS convention on July 31 and he will visit with those folks at the convention.

Housekeeping Schedule: Jim Shook had turned-in his key last month; need to revisit the housekeeping schedule because Jim had signed-up thru November. Tracy noted he was planning to do the cleaning but didn't have the time; he had managed to scrub the toilets.

New Business:

No new business.

Next Business Meeting: Scheduled Date would be Thursday, August 1 but President Roth will be absent. Director Jerry Michels indicated he would be gone also. President Roth recommended deferring the meeting one week to August 8. This will also allow Treasurer Virgil Doyle to put the financial information together since he cannot get it together on the first of the month.

ARM Work Dates: July 13  
July 27  
August 10  
August 24

Meeting Adjourned.

---

**Future Events:**

July 11, 2013	ARM Business Meeting
August 1, 2013	Tentative: ARM Business Meeting
July 31-Aug 4, 2013	Santa Fe Railway Historical & Modeling Society Convention in Flagstaff, Arizona

---

**Classified Advertisement:**

**For Sale:** Lionel post-war O gauge equipment only, no trains. 3427 milk car/platform; 3656 stockyard; 397 coal loader; 313 bascule bridge; 151 semaphores; 145 automatic gateman; 1045 operating watchman; track changers; transformers; track; buildings and more. Would like to sell all at one time. Inventory list/photos available upon request. Mike Bruegel; pnone \*06-353-5545 or e-mail at mbruegel@aol.com

**Cleaning Schedule for 2012 / 2013:**

January	
February	Tracy Ball
March	
April	
May	
June	
July	
August	
September	
October	
November	
December	

---

### Recent Photographs:



Virgil Doyle working on switch panel for Zita. Picture on left was taken on Saturday, July 13, while picture on right was taken two weeks later on Saturday, July 27 while Virgil was attempting to find and debug a problem.

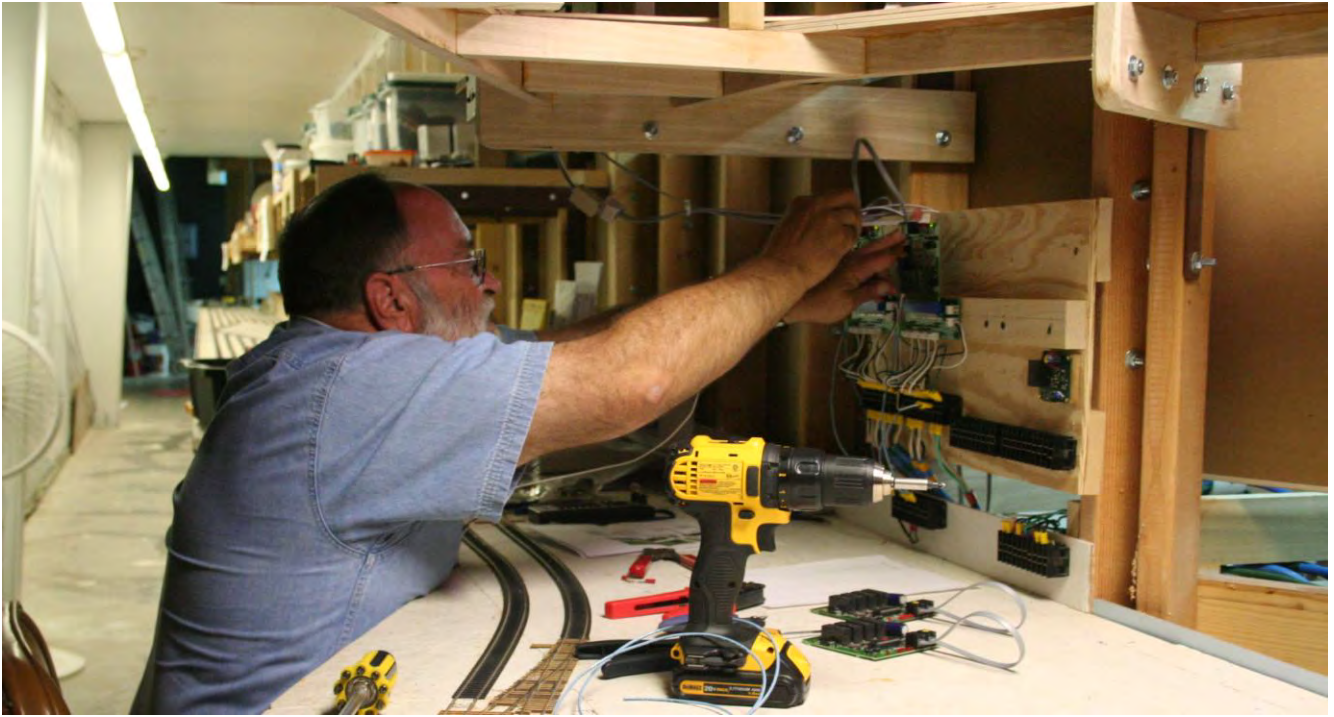

Jerry Michels working on the train detection equipment installation in the staging yard.



To make the train detection system work in the areas with double track, a different set of wires is required thus Jerry started pulling a red cord to provide power for the second main track.



On June 24, we had a special group of visitors at the ARM, the local Model A Club. Photo by Jerry Michels.



Line-up of Model A Fords outside the ARM – a beautiful display of cars from the past. Photo by Jerry Michels.



A closer view of one of the Model A's. Photo by Jerry Michels.





A closer view of another Model A with the rumble seat open. Photo by Jerry Michels.



# Run 8

September, 2013

## President's Message

*By Bob Roth*

On July 31, I headed West to Flagstaff, Arizona to attend the 33<sup>rd</sup> annual convention of the Santa Fe Railway Historical & Modeling Society (SFRH&MS). A key feature of this convention was a ride on the Grand Canyon Railway from Williams to the South Rim of the Grand Canyon and back with plans for stops for photo run-bys. I was especially looking forward to this train excursion as the Grand Canyon Railway is one tourist railroad that was on my list of tourist trains I want to ride. The train was specially chartered for our convention and was to be a mixed train to be pulled by the steam engine, former CB&Q #4960.

Thursday, August 1<sup>st</sup> was a long day as we had to be on the bus at 7:00 AM to travel to Williams, approximately 40 miles to the West from Flagstaff. At Williams the cars for our train were already assembled and we were able to watch the steam engine couple to the train. Our train consisted of three old Harriman heavyweight coaches, two tank cars, three ballast hoppers, a flat car and a relatively freshly painted Santa Fe caboose No. 999727. There was a bit of discussion among a handful of SFRH&MS members concerning the red color used on the caboose... There had been a lottery held the night before for a limited number of members to ride on the caboose and unfortunately (or maybe fortunately) I was not one of the "lucky" few. Around 9:00 AM we were allowed to board our train and shortly thereafter we were on our way.



Shortly after departure, John Signor passed by with a map of the railroad track and facilities at the Grand Canyon along with a map of the rail line between Williams and the Grand Canyon which also had a profile view of the rail line. The big surprise was the change in elevation along the length of this line as it started at Williams at an elevation of 6761 feet, dropped to an elevation of 5811 feet at the Willaha siding near the middle of the line and then climbed back up to an elevation of 6866 feet at the Grand Canyon. Little did we know what was in store for us on this trip...

The first part of the trip was uneventful as our train headed North and pulling into the Quivero siding where the freight cars were uncoupled from our train for our first photo run-by and those of us interested in taking pictures of the train were allowed to get off the train. The engine with the passenger cars then pulled out of the siding and was backed down the track over a mile before they switched direction and came back toward us at speed. After a second run-by, the train pulled back into the siding to wait until the regular Grand Canyon train passed by. The order of our train was then switched with the freight cars at the front and the passenger cars at the rear and then we backed down the track a few miles to a wash that was deemed to be a good spot for another photo run-by.

I decided to stay on the train during this second run-by as it was hot out in the sun. We did two run-bys and then stopped to pick-up all the folks that had gotten off the train before resuming our trip to the Grand Canyon. Up to this point everything was going pretty-much according to plan although slightly behind schedule until we encountered a problem climbing back out of the "bowl." What I did not mention was the grade on this rail line is 3% on both ends which is very steep for a train to climb and as our train had neared the peak of the 3% grade it had stalled or "spun-out" on the grade. Apparently the sum weight of our train with the freight and passenger cars was too much for the steam engine to pull up the steep grade thus we were forced to back down the grade for a good distance where the passenger cars and caboose were uncoupled and parked on the track while the steam engine took the freight cars up the hill to Apex siding. Given the rules for railroading in "dark territory" (no signals) it took at least an hour and a half for the steam engine to climb the hill with the freight cars, park them on the siding, and come back for the passenger cars. In the meantime, we had run-out of drinking water on the train and had gotten really thirsty in the heat until the railroad was able to send a rescue crew with fresh drinking water.

Given this delay to our planned trip, our plans were changed as we steamed to the Grand Canyon finally arriving at the South Rim Station around 2:30 PM where our lunch was waiting for us. They decided to give us a longer break at the South Rim in-part to let the regular train depart at 3:00 PM and to allow some time for us to sightsee at the South Rim of the Grand Canyon given the cancellation of further planned run-bys on our return trip. The return trip was uneventful and we arrived back at Williams shortly after 7:00 PM. Unfortunately we were not allowed much time at Williams before we had to load on the buses to head back to Flagstaff, arriving at our convention hotel after 8:00 PM. This made for a really long day, but it gave us all some interesting stories to tell when we got back home.

The rest of the convention passed very quickly. Friday and Saturday during the day there were clinics to attend and a vendor room to shop in. Clinics presented included "Aging and Weathering Steam and Transition Era Models" by Tony Thompson and Richard Hendrickson; "Ready to Run in 3 Hours – Santa Fe Edition" by Andy Sperandio; "The Grand Canyon District" by John Signor; "The Modeling Industry Viewpoint" by Frank Angstead (Intermountain Railway Company); "Grand Canyon National Park" by Shawn Eccles, National Park Service; "Santa Fe Passenger Service in Perspective" by James Brown; "Building Santa Fe and Southwest Structures" by Bob Foltz; and "Life at Seligman" by Steve Patterson. Overall these clinics presented both historical information about the Santa Fe Railroad, the Grand Canyon Railroad, and information on modeling techniques.

Friday evening we had a special presentation by Stephen Fried, author of the book “Appetite for America: How Visionary Businessman Fred Harvey Built a Railroad Hospitality Empire that Civilized the Wild West.” Saturday evening was the awards banquet and the convention wrapped-up on Sunday morning with the annual business meeting for the Society. Overall I had a great time and I was able to visit with many friends I have made at these conventions over the last several years and I hope to make the convention in Fresno next year.

Around the ARM, progress continued on the layout construction and on the garden layout but I don’t have much to report. Due to a death in the family I had to leave town and miss the August 26 work day and at the end of the month was not versed in progress to-date at the end of August.

Next Meeting: The next Business Meeting would be scheduled on Thursday, October 3 at 7:30 PM. As I write this there is no planned clinic following the meeting.

Bob Roth



SFRH&MS Excursion ready to start boarding to depart South Rim at Grand Canyon National Park.

---

## MEETING MINUTES

### ARM Business Meeting

August 8, 2013

#### Old Business:

Meeting Minutes from July: Published and distributed in Run 8 sent via e-mail (very early in the morning): Approved as Published.

Treasurer’s Report: Treasurer’s Report for May: (President Roth did not have a copy last month)  
Approved as Read.  
Treasurer’s Report for July:  
Approved as Read.

Noted there is a liability against the garden account in the amount of \$299.96 for 4 turn-outs and another \$460 plus change for a box of 12 five-foot long pieces of straight track.

Car Sales Report/Update: No direct sales in July.

Jerry Michels reported he had sent a bunch of cars to Gene (MPHS) and he sold \$400 worth at a prototype modeler's meet in St. Louis thus we made \$200 there. Jerry also reported that as-of today we had made \$726 in profit this year although we still have around \$400 more in sales to be received.

New models: Jerry has been trying to get in touch with Tangent Scale Models and Exact Rail Models but with the national NMRA convention and other prototype modelers meets he has not been able to get in touch with them.

Question was asked about the PRR X29 Boxcars; we had received 90 cars back from the Texas Western Club in Fort Worth. 300 cars were ordered and the cost for these cars was split with the Texas Western Club. We kept 12 cars and sent 288 cars to Texas Western, and we recently received 90 cars back from Texas Western. Jerry read a letter with the accounting received from Texas Western and noted they had included a check with the letter, but there were a lot of questions concerning why they sent the cars back. President Roth noted he had caught some news that Texas Western had lost their home and was having to move. Member Leonard Opdenhoff stated that Texas Western is moving approximately 2 miles to the West to Forrest Hills. Jerry stated he needed to read thru this more closely.

Layout Construction:

Progress: Tracy reported the table at Panhandle was completed and is ready for roadbed and mainline switches to be installed. He had the Celanese spur started and should have it completed by next week and then he will come around back to Pampa. When he gets this done, the track-laying guys will have a lot to do. Tracy also noted Jerry had been working on wiring in the back and experimenting with a track detection system and Virgil was still working on the switches at Zita. We can now run down the track from the Yard to the spike sticking-up at the turn-out going into Zita.

Jerry noted he is running a second line for a second bus where we have double main track; relative to making a signal system work that senses the load on the track (from a train) in a given block, we cannot have one bus hooked-up to both main lines. Jerry noted this is a learning process. There was further discussion concerning wiring of turnouts to make them work; Jerry was running a red extension cord for the new bus thus the blue line will be the power source for the outside main track and the red/black cord will be the source for the inside main. Sidings will also need to be separated and probably powered with a PM-4. If we are going to do a signal system on the layout we need to plan for it now; discussion was that we probably do want to have a signal system. We do not want to install everything and then have to rip a lot out to add a signal system later.

Phillip Pratt Memorial Garden Railroad:

President Roth noted he spent time out in the garden pulling weeds, particularly a number of large goats heads (stickers). Tracy stated he had also pulled a bunch of weeds out of the

garden. Straight track was received and also 4 switches on back-order were received. An effort was initiated to start connecting together the track pieces laid on the concrete roadbed; pieces of track on the curve at the northeast corner of the garden were fastened together by student member Cory Gabel on Saturday. Question was asked concerning what we were planning on planting in the garden; we were expecting the Master Gardeners to assist in plant selection so the garden will be xeroscaped

#### Building & Grounds Update:

Mowing was done by Tracy Ball with some assistance from his dad; Tracy had sent some pictures and President Roth will attempt to download the pictures into the next issue of Run 8. Tracy noted he had seen a few horny toads around the property while he was cutting the grass. Weed-eating is required.

Question was asked about bee hives; one of the hives had died-out during the winter but the other ones are still going.

#### News of Other Organizations:

Santa Fe Museum: No recent news.

RAPS: No recent news.

NMSLRHS: They continue working on restoration of ATSF 2926. They had a little video at the Santa Fe convention but President Roth noted he did not have the time to stand and watch it.

#### Recent/Current Promotions: No new promotions during the month of July.

President Roth noted he had to restock the flyers at the Visitor Center at the Civic Center. He had counted a sum of 60 flyers and dropped them off at the Visitor Center on our last Saturday work day so we can see how long the flyers last.

Museum Guide: No further work on draft guide to the ARM this month due to other projects and priorities.

TPRHS Documents: President Roth noted he had visited with Bill Childers, the SFRH&MS representative overseeing the archives at the railroad museum at Temple concerning transfer of these files to the Society's archives; they may be able to come and pick-up the records here. President Roth initiated an inventory of the records with the goal to find records pertinent to ARM layout so those records can be scanned before we release them. President Roth noted he was filtering thru the one open box with all the files on the cotton platforms and he had pulled one file for a Happy, Texas. As he was looking at a sketch in this file he felt the lines and the lettering on this sketch looked awful familiar to him and then he had observed his initials on the bottom of the sketch – it was one he had done approximately 30-years ago when he worked for the Santa Fe – he had totally forgotten about it. The sketch was to retire the cotton platform in Happy, Texas...

Housekeeping Schedule: Need help, particularly since Mr. Shook is no longer able to be with us.

#### New Business:

UP Big Boy 4014: Jerry Michels noted that Union Pacific bought the 4014 from the Southern California Railroad Museum with the intent to restore it. A lot of people thought that would never happen because the locomotive is so large; it is the largest steam locomotive ever built.

It was unknown if this locomotive was in Cheyenne yet. President Roth noted there was a lot of discussion at the Santa Fe convention about the Big Boy and the net of the discussion was that out of all the Big Boys that were saved, this was probably the one that was in the best shape.

President Roth noted the last news he had about the Big Boy in Dallas was that it was still at Fair Park along with a Santa Fe F-7 in the red and silver warbonnet paint scheme and it was scheduled to be moved to Frisco around July 28 but they are not advertising this move. All the rest of the Museum's collection has already been moved. The information came from The Cowcatcher. This locomotive will be sandwiched with a bunch of other cars for braking purposes. President Roth noted that of the Big Boy locomotives that were built, this was the one class of locomotive that had the most members of its class preserved and they are scattered all-over the country.

Memorial Plaques: President Roth noted he needed to call Janice Sowle; she had called and left a message while he was in Flagstaff about Memorial Plaques and what she needed to do. Director Tracy Ball had proposed we do memorial plaques to recognize particularly our long-time members that are no longer with us. We hadn't quite figured-out exactly what to do; one thought was a little memorial plaque maybe with a little picture and information what years they were members, Charter Members... Another issue is where to put it. A suggestion was made to continue with the bricks – you can get 1-foot by 1-foot bricks. This needs to be explored further...

Completion of the Lower Level of the Layout: President Roth suggested a new initiative to set a date to complete the track around the lower level so that it is mostly operational. Suggested we try to have this done by November. Goal would be to hopefully be able to run trains all the way from the Staging Yard to Amarillo Junior and on to the top of the helix. Tracy stated he doesn't like goals. It was also suggested we try to have the outer loop on the garden layout operational then too. The thought is that November is National Train Month thus the idea would be to have an Open House on our first work Saturday in November and show-off our progress. (It was noted the second work Saturday in November falls on Thanksgiving weekend.) If we can show-off running trains, more power to us. We can go a little further and possibly kick-off that day with a hobo breakfast; we haven't done a hobo breakfast in a long time. President Roth noted he hadn't talked to Tracy about this idea yet... Tracy noted he wanted to have the bottom level done by the end of the year anyway. President Roth stated he figures we will have problems at a number of frogs and things like that.

Final Comments: President Roth discussed some of his experience at the Santa Fe Railway Historical & Modeling Society Convention in Flagstaff. He had a great time. Noted the Grand Canyon Railway is operated by the same company that operates the concessions at the South Rim of the Grand Canyon, Xanterra Corporation. The excursion to the Grand Canyon was pulled by their steam engine #4960, a former CB&Q steam engine that was in beautiful condition; there had been an article in a recent issue of TRAINS Magazine concerning this engine getting its 1450 day inspection over the past Winter between the end of last tourist season and this tourist season.

During the excursion and at the convention it was noted that Xanterra is very environmentally oriented and they had lengthy discussion about some of their environmental issues; one in particular was their steam engine runs on vegetable oil. They said if it smells like French Fries it was because of the oil they are burning. They only run the steam engine mainly on the first

Saturday of each month; our excursion was a special run. They stated the cost to run the steam engine was approximately three times the cost to run their diesel-electric locomotives. Water: They don't do water bottles any more. To give water, they carry jugs and put them in a cooler and they provide cups for people to get a drink of water. They also have a box to put the cups in for recycling the plastic. It was a very interesting trip although we had one major hitch in our excursion.

An interesting feature of the Grand Canyon Railway was that it started at Williams at an elevation of around 6900 feet and descended to around 5800 feet in the middle of the line and climbed back to an elevation of around 6800 at the South Rim of the Grand Canyon. Some of the history behind the railroad was that it was a bunch of miners that had found some ore up near the canyon that had no means to haul their ore out of the area so they campaigned to have a railway built. Some of the miners started the tourism business building camps near the South Rim and bringing people up to the canyon by stagecoach. Finally in 1895 the miners found a company to finance construction of the railroad and construction was started. The financier was kind-of shaky, the railroad was built approximately 52 miles, around Anita and that was where the railroad ended. In a short period of time the mines played-out, the financier went belly-up and the railroad itself went belly-up and was put-up for sale. The Santa Fe was part of a group that bought the railroad and ultimately they took-over full control of the railroad and pushed it up to the South Rim. The gentleman that was the main campaigner for the railroad was one of Teddy Roosevelt's Rough Riders and he was killed during the charge on San Juan Hill in Cuba thus he never got to see the fruition of his efforts with the completion of the railroad. A lot of interesting stories...

Concerning the "hitch" in the Society's train excursion to the Grand Canyon; the train was a mixed train with some freight cars and three old Harriman coaches. One feature not mentioned yet about the "bowl" the railroad runs through was that the railroad traverses 3% grades to climb out of that bowl. The plan for the train was to do photo run-bys of the train down near the bottom of the bowl and then to go on to the Grand Canyon. After doing the first two run-bys, the train was put back together and it proceeded on toward the South Rim, but it stalled-out on the climb up the 3% grade. The train had to be backed down the grade quite a distance, the passenger cars uncoupled and left on the track while the engine took the freight cars up to the nearest siding. The passenger cars were stranded for about an hour and a half...

The Friday evening feature was a presentation by Stephen Fried, author of the book "Appetite for America – How Visionary Businessman Fred Harvey Built a Railroad Hospitality Empire that Civilized the Wild West." This was a very interesting presentation... The whole convention was interesting with good clinics and good historical information.

Clinics: No long-term schedule for clinics at the moment.

ARM Work Dates: August 10  
August 24  
September 14  
September 28

Next Business Meeting: Scheduled Date is Thursday, September 5.

Meeting Adjourned.

---



## **News Items:**

Museum of the American Railroad: The move of the “Big Boy” former Union Pacific 4-8-8-4 steam engine #4018 from its home at the Museum’s old location at Fair Park in Dallas to its new home in Frisco was completed on August 25. The move was started on Sunday, August 18 when the engine was moved from Fair Park to BNSF’s yard in Irving where it spent the week before the final leg of the move to Frisco on August 25.

“Big Boy” #4014 to be Restored to Operation: The Union Pacific Railroad purchased “Big Boy” locomotive #4014 back from the Southern California Railroad Museum with plans to restore it to operation. More news on this as it becomes available.

## **Railroad Historical Events:**

Historical events significant to railroads that occurred during the months of August and September included the following:

Aug. 8, 1829	First run of the “Stourbridge Lion.” (This was an early steam engine built in England imported into this country.)
Aug. 28, 1830	The first steam powered train was run on the Baltimore & Ohio Railroad.
Aug. 28, 1864	First permanent Railway Post Office Route was established.
Sept. 1, 1935	The National Model Railroad Association was organized in Milwaukee, Wisconsin.
Sept. 3, 1930	Thomas Edison ran the first experimental electric passenger train between Hoboken and Montclair, New Jersey.
Sept. 10, 1972	San Francisco Bay Area Rapid Transit (BART) carries first passengers.
Sept. 20, 1850	US President Millard Fillmore signed the first Railroad Land Grant Act.
Sept. 23, 1874	The East Broadtop made its first run.

## **Future Events:**

September 28, 2013	New Mexico Steam Locomotive & Railroad Historical Society – Free Open House at the ATSF 2926 Locomotive restoration site in Albuquerque; 9 AM – 4 PM.
Sept. 28 – Oct. 2, 2013	Chama Steam Fall Madness – Spectacular Railfan Excursion featuring engines #315 and #463 with lots of photo-ops and run-bys. For further information: Chama Steam (575) 756-1674 <a href="http://www.chamasteam.com">www.chamasteam.com</a>
October 3, 2013	ARM Business Meeting
December 7-8, 2013	Oklahoma City Train Show

### Cleaning Schedule for 2012 / 2013:

January	
February	Tracy Ball
March	
April	
May	
June	
July	
August	
September	
October	
November	
December	

---

### Recent Photographs:



Jerry Michels working on Amarillo Junior Yard on Saturday, August 10.



Carter Osborne with family in Staging Yard on August 10.

# Nuts and Bolts: Some Technical Aspects of the Amarillo Railroad Museum Layout

Jerry Michels

It is great to see the layout progressing toward completion of the lower level so that by November, per President's Roth's charge last month, we can have trains running from the Canadian staging yard all the way to Amarillo. That will be a significant accomplishment and finally give us an operating layout. If you think about it, our layout from Canadian to Amarillo is much larger than almost any home layout in the region. Hopefully being able to run trains will also be an enticement to others to join the ARM.



Along the lines of completing the lower level, I wanted to give our readers an idea of the wiring and DCC features we're implementing as the work continues. As you know, we use Digitrax as the backbone of our DCC system. We've been using it for years, and once you spend a bit of time working with the system, it is fairly easy to use. That doesn't mean you can always just plunk a locomotive down on the track and run every bell and whistle (literally) without having some knowledge of the system, but you can usually get a locomotive to run if you know the basics. I won't go into a detailed discussion of operating the system here, but concentrate more on how the system is set up from a wiring aspect.

Our system starts with a Digitrax DCS200 Command Station. This unit is the "brains" of our system with an 8 amp maximum output. It delivers power to the rails, receives input from throttles connected

to it, sends out commands to the decoders in the locomotives, watches out for shorts, and allows decoders to be programmed. For all practical purposes, it handles it all. But in reality, on a layout as large as ours, it is impractical to just hook up the DCS200 to the rails and run it. If this was the only device on the layout, everyone would have to connect their throttles to the unit to run their train. This would limit us to two trains at any one time. Of course this is not the case. Stationed around the layout are UP5 Universal Interconnect Panels shown at the left. These allow two throttles access, one plugged into each jack on the front of the panel. Actually, there is a third jack on the right side behind the panel, but that is difficult to access, and is usually reserved for other uses. There is an LED between the two jacks that glows orange when track power is on. That is really all it is there for. It is a bi-colored LED, and since the track power is AC, it switches back and forth between red and green 60 times per second, which appears as orange or perhaps dark yellow. We also have "generic" interconnect panels in some locations which are identical to the Digitrax panels, but without the LED or Digitrax markings.



These panels are all well and good, and quite necessary since you need to plug in a throttle to access the system. However, most of our members have gone beyond an "always tethered" throttle to a DT400R, which allows wireless radio or infrared control. To use these features, we

presently have one UR91 Simplex Radio Equipped/IR Receiver Panel. This panel handles both radio and infrared throttles, and allows tether-free DCC use. Although the panel does accept infrared, this has to be a line-of-sight connection, that is, if the throttle can't "see" the panel, it won't receive the commands. This is the same as your TV remote. You can't send infrared through a wall! For this reason, we strongly recommend against getting an infrared-only throttle. Radio-equipped is much more reliable, and can go through walls and other obstructions. This panel looks similar to the UP5, with one jack on the right side and the IR detector on the left. It also has a track status light. Our UR91 is currently mounted on the west side of Amarillo Junior Yard, and paired with a UP5 to give three throttle access points.

As a quick note, you have to plug into a UP5 or the UR91 to run a locomotive on the layout. The process is simple. Put your locomotive on the track and plug your throttle into any UP5 on the layout or the UR91. On the throttle, press the LOCO button, then enter the number of your locomotive and then press the LOCO button again. That's all there is to it. If your throttle has radio or infrared features, you can then unplug from the system and run normally. Another note, Digitrax provides a way to run a non-DCC locomotive by assigning the locomotive address 00. This will send commands to any non-DCC locomotives on the layout. However, and this is important, due to technical problems with how the 00 address works when using circuit breakers and detection systems on our layout, this function has been permanently disabled. **If you want to run a locomotive on our layout, it has to be DCC equipped; no if, ands or buts. If you try to violate this rule, it will hum, but it won't run.**

OK, that is the basic system we have, and the parts of the system with which most will interact. However, the system is more complex than that, and will get even more complex as time goes on. The first thing I want to bring up is short circuits. In the basic system, if there is a short circuit; which could be from a derailment, some metal object Guy places across the track, or something I improperly wired, the DCS200's circuit breaker will shut down the entire system. That's a good thing, but if Virgil is running a train heading west from Canadian and I have a derailment in Junior Yard, it is pretty obvious that Virgil would appreciate it if my mistake doesn't throw his train into emergency. In order to prevent such a thing, we are breaking the layout into blocks and installing a device called a PM42. This device allows the main power feed from the DCS200 to be broken down into four



separate blocks, each with its own short circuit protection. So, with one of these devices installed, my derailment in Junior Yard will only affect Junior Yard, and not Virgil's train in Canadian. The PM42 circuit breaker for my block will trip and shut off power until the derailment is cleaned up, but all other blocks will remain powered. We will use the PM42s as our basic block structure. The power feeds for each part of the railroad we want to be electrically isolated, especially for signaling, will run be controlled by a separate PM42 output. We can have as many PM42s as necessary; only limited by the power delivered by the DCS200.

We currently have nine blocks installed; each using one PM42 output. As you might imagine, these devices will be the cornerstone of our power distribution and circuit protection. A great feature about Digitrax is that the system is designed to easily place different devices "downstream" of the command station. So, a system can be set up to run from the DCS200 to a bank of PM42's which cover the main areas of the layout, but if there is a need for additional circuit protection, another

PM42 can be placed “downstream” to break a main area into four smaller areas. As an example, imagine using one output of a PM42 to protect all of Junior Yard. The other three could be protecting the two main lines and the Junior Yard lead. But, we don’t want all of Junior Yard to shut down each time Tracy derails his FTs in the roundhouse area. That might especially frustrate Dave making up a consist on Track Six. So, we run the Junior Yard main area PM42 output to another PM42, which gives us four blocks within Junior Yard. As you can see from the diagram, this can be repeated as necessary to get as many smaller blocks as we need to address power management on the layout. Theoretically (and very expensively), you could have each track in a yard electrically isolated from all other tracks in the yard. The idea, however, is to judiciously block the railroad so that we cover the

maximum amount of track with a single PM42 output as we can, without making it so large that operations are interfered with when a short occurs. If you give it a little thought, you can also see how these electrically-isolated blocks can play into a signaling system. More on that later.

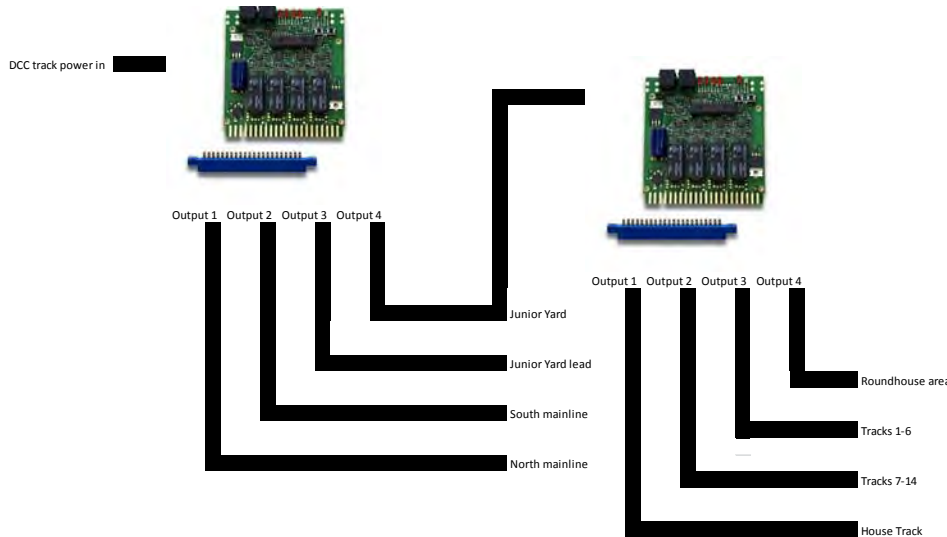

An interesting little device we have in use is an auto reverse loop detector;



called an AR1. You can use one output from a PM42 as a reverse loop detector, but we decided to have dedicated reverse loop detection. Right now, we use an AR1 to control the balloon track on the Canadian staging yard. We will use another at the wye in Canyon, and perhaps a few other places where we have a reverse loop or wye configuration. The use is pretty straight forward. The AR1 allows a train to circle back on itself, as in our balloon track, and automatically reverses polarity without causing a short circuit. This is a transparent operation, and unless some technical problem comes up, this device will just keep doing its thing. The AR1 installed on the balloon track has been there for at least three years, maybe four or five. I installed

it, set the sensitivity, and we have not had a problem. There are a few comments or caveats. The AR1 works even if all the locomotives have not crossed the gap coming out of the loop, as in a lash-up of diesels. I’d like to try this with a lighted passenger train to see how it works, or if there are limitations. Bob, it seems a perfect experiment for the SF Chief! There is a scenario, with a pretty good chance of never happening, where as a locomotive exits the loop a lighted car, helper locomotive, or any equipment that places a load on the track enters the loop at the exact same time. This might “confuse” the AR1, and I don’t exactly know what would happen. But, then again, this should be a very rare event, and if it happens, we can handle it. Our balloon track is pretty long, and hopefully most trains will be completely within the loop at one time before it exits.

In closing, I will mention that if you need help getting a locomotive to run, or want to program various features into today's amazingly complex decoders, there are two things you can do. First, we keep a rack of articles and instructions in the southeast corner of the layout room, where the guts of the DCC system resides. Feel free to go through those items, but please put them back when you are done. Second, with today's decoders, it is more important than ever to keep your instructions, and bring them with you if you want to program your locomotive to do anything beyond simply running it. Setting the sound level, accessing features like brake squeal, flashing lights, chuff rate, generator or dynamic brake whine, etc. are more and more brand specific, and no one I know of in the club retains all that information. I have run into this myself. Broadway Limited has a pretty detailed startup, shut down, and idle mode procedure for its locomotives. I have a set of Santa Fe RSD15s, and one time I accidentally shut them down by pressing some button, and had no idea how to get them back up and running. Therefore, what is used to control the whistle volume in a Kato unit is most likely different than with a Bachman Spectrum, Broadway Limited, or Athearn Genesis unit. Fortunately, within a manufacturer, their procedures stay pretty much the same, depending on if the model is steam or diesel. One thing I would like to do is get copies of all the different instruction manuals and keep them at the club, so if you think of it, bring your instruction manual with you and I will scan it and make up some PDFs we can keep at the club. This also applies if you installed a decoder into a non-DCC locomotive. If you have the instruction sheet for the decoder and know the locomotive in which you installed it, write the locomotive details on the sheet, and I will get it scanned, and you will have a record at the club.

That's it for this time. As I have time to write, I will get into other aspects of our control system. If anyone has questions about our system, feel free to drop me an e-mail or catch me at the club.



# Run 8

November, 2013

## President's Message

*By Bob Roth*

Let me apologize once again for not getting the newsletter completed before the Business Meeting. It is already past the first of November as I finally was able to sit down to write this message; the whole month of October just blew past me...

We all need to thank a number of folks that have been working a lot of extra time these last few weeks particularly in an effort to get the model railroad ready for our scheduled Open House on Saturday, November 9. The real big push on the HO scale layout is an attempt to complete the main line track all the way between Amarillo Junior Yard and the lower level Staging Yard and as I am writing this the work is still in progress and we will have to see how far they get. Tracy has been working on the spline roadbed thru Miami with just a short stretch left to reach the edge of the plywood deck at Canadian. We had significant help from Ken laying cork roadbed on the plywood deck at Canadian and also on the spline between Pampa and Miami, and Ken also helped lay track from the Staging Yard thru Canadian and in other places. David Jusiak was also working to lay track and install turn-outs at Kingsmill and Pampa while Jerry Michels and Guy Pigg worked to extend the buss cable for track power and add power drops from the newly laid track. Virgil Doyle is working behind them installing and wiring the Tortoise switch motors.

Anyone wondering where I have been on all this; most of my time has been spent outside working on the G-scale track in the garden. My goal is to have the outer loop of track in the garden complete for the Open House however, as I am writing this message I am only approximately 50% complete with the track installation and I have a long way to go. I am nervous that I may not get the track installation complete, but I will make the best effort I can in this effort. The time change from Daylight Savings Time to Standard Time will also hurt me in this effort as it will be getting dark around 6:00 PM and this will make it difficult to work in the evenings and I don't have much time left... The rest of this story to be provided next month...

Another project I worked on this month was a letter to the City of Amarillo asking for a re-assessment of the City's drainage fee being assessed to the ARM. Back in September we found our assessment had jumped up to over \$90 per month. I called the Public Works Office and was told that we were being assessed for over 101,000 square feet of impervious area (approximately 20% of our total property). I took the time to measure the roadways and all the assorted pads on our property left from the Air Base structures that had been demolished several years ago and I came up with a figure of



around 50,000 square feet of impervious area excluding all the railroad track and rail cars sitting on the track as I do not consider the railroad track to be “impervious” given the tracks were laid in the dirt years ago and they grow vegetation very well. The rail cars themselves may be impervious, but they are movable on the track and the water that falls on the cars drips onto the ground. Another factor I noted in my letter was that our property does not drain via any City-owned conveyance; instead our property drains to the North onto the right-of-way for US Hwy. 60 where it is then transmitted toward a playa lake located on the North side of the BNSF railroad tracks. I made the effort to document this letter with a number of photos with different views around our property and I pushed to get this letter done before I started my push to pull the newsletter together.

Next Meeting: The next Business Meeting would be scheduled on Thursday, December 5 at 7:30 PM. As I write this there is no planned clinic following the meeting.

Bob Roth

---

## MEETING MINUTES

### ARM Business Meeting

October 3, 2013

#### Old Business:

Meeting Minutes from September: Published and distributed via e-mail around 8:30 AM.

Minutes Approved as Published.

Treasurer's Report: Treasurer's Report for September:  
Virgil noted the correction from last month had been made.  
Treasurer's Report was Approved as Read.

It was noted that Treasurer Doyle had sent some information concerning merchant fees and pricing for Amarillo National Bank; question was asked how their fees compared with Bank of America. Virgil is looking at this now and has an appointment with the folks at ANB tomorrow. Goal is to try to move all our accounts to ANB. Tangent Scale Models was paid using our line of credit with ANB.

#### Car Sales Report/Update:

Some funds were received from the Missouri Pacific Historical Society from car sales at 2 different shows, one in St. Louis and one in Jackson, Arkansas; net income for the ARM was \$230.50 and we had 2 sales directly.

Director Michels noted discussions with Athearn about doing custom cars and they would only give us 2 different numbers.

Tangent Models: BN covered hopper with Fort Worth & Denver reporting marks: We still plan to advertise these cars in advance of receipt and take advance reservations.

Director Michels stated he needed to visit with Intermountain in the next month or two about running more ART reefers. Jerry noted we don't want to get any more of the more modern cars, but we are almost sold-out of the 1950's kits; we only have about 15 kits left. Intermountain may be sending a production order in around February. We probably want to do these cars on our own.

#### Layout Construction:

Progress: Tracy completed the risers for the plywood decking on the West end of Pampa; he still has to get the plywood connected to that spline extending for the CO&W and then he will be off to Miami. David continued laying track on the main line and is now approaching Pampa. Virgil Doyle connected another crossover near the East end of Amarillo Junior Yard. Jerry Michels extended the wiring for the main power bus and started installing power drops and Tortoise switch motors on the mainline turnouts in the East Tower area; one switch motor in the East Tower area will require some custom work to fit it in and that may require cutting the L-girder. Panhandle will be next. Jerry noted we need more wire cradles installed between Panhandle and Kingsmill so the bus can be extended. Given the work completed, we can now operate trains up to the West end of Panhandle.

#### Phillip Pratt Memorial Garden Railroad:

Major work was completed on Saturday, September 28 as we all focused our attention on the garden and completed the laying of concrete roadbed around the front half of the garden. The next step, the hard part, will be to install the track on the roadbed. President Roth noted he is working on cleaning the dirt out of the rail joiners and the plan is to install a dielectric grease in the joiners when the track is assembled to help with the conductivity and also to help keep dirt out of the joints; this should help us to be able to run trains on track power around the garden until we can get battery power installed in some equipment. Also on Saturday the 28<sup>th</sup> we salvaged the small gravel that had been used to ballast the track that had been laid in the garden; since it was wet when we removed it, we piled the ballast onto a piece of landscape fabric so that it can dry-out. President Roth noted he has a plastic colander that works very well as a sifter in filtering the gravel out from the dirt and the plan will be to reclaim the gravel after it dries-out. David Jusiak has a report on battery control systems coming later in the meeting.

#### Building & Grounds Update:

Mowing was done by Tracy Ball with some assistance from his dad about a month ago, but with the rain, the mowing needs to be done again.

The TV antenna and the wall protection are still outstanding.

#### News of Other Organizations:

Santa Fe Museum: No recent news on the Museum but with the City buying the Santa Fe depot that may open new things.

A question was asked why we were carrying the news of other organizations and President Roth explained he brings this up for information. Part of the reason is there is us, there is RAPS working on restoration of the Madam Queen; we've got Jerry Buttel down to the South with his collection; and then we have this Museum and we can't all have the same thing. President Roth noted that he and other members of our Board had

attended some of their early organizational meetings and President Roth had also attended their periodic meetings they had with the Amarillo Area Foundation to keep-up with what they were doing. It's just trying to keep-up. Some of their folks had indicated that after they get their home they might come to us and ask us to move-in with them but they were told that we were too invested out here now.

RAPS: They are working on cleaning-out the tender. They broke the welds on the hatches to the tender and got down in there and started cleaning the crud out. There was a lot of scale inside the tender.

NMSLRHS: They continue working on restoration of ATSF 2926.

Recent/Current Promotions: No new promotions during the month of September. President Roth made some minor updates to the ARM brochure before giving a new copy to David for reproduction. David had brought out 150 copies and they need to be folded if anyone is interested.

The Texas Tourism Center on I-40 sent an e-mail message stating they were low within a week after they were given the previous 40 copies of brochures.

Museum Guide: No further work on draft guide to the ARM this month due to other projects and priorities.

TPRHS Documents: President Roth worked on inventory the evening when we experienced the heavy rains.

Memorial Plaques: No further effort toward memorial plaques to recognize our long-time members that are no longer with us.

Housekeeping Schedule: Need help.

### New Business:

Planning for November Open House: The thought is to put fliers at the hobby shops to advertise our Open House in recognition of National Model Railroad Month. The question is what to say... Do we want to be open on both the 9<sup>th</sup> and the 23<sup>rd</sup> or just the 9<sup>th</sup>. Quick response was just the 9<sup>th</sup>. What are we going to do? The thought is primarily to get some publicity out there we are open; also to set some trains up that we can at least run backward and forward. The thought was expressed that with the month of October, we ought to be able to run around to Pampa by the November 9<sup>th</sup> date and hopefully we can have the first 5 tracks in Junior Yard working. President Roth noted he will be working out in the garden during this time trying to get that ready.

Battery Operation: David Jusiak noted he had gone to Hobby Time and had visited with Don Harris there. They had browsed some magazines for information and he had come with two particular articles on DCC for large scale. It shows what they're using; he read it although he doesn't understand it all. The Beginners Guide shows different controllers, how to set them up. At the end of the article it talked about "no track power" systems. For non-track-powered systems there is no central command station and it talks to multiple decoders. In the system each decoder has its own wireless command station receiver which makes it more like a radio control. David had also talked with two manufacturers; one of them, NCE, sent David a system reference manual for the decoders they have for the larger trains and some literature about it. He also sent some other information. In talking with these gentlemen, both of them had set-up

a single track loop railroad with track power. As they progressed they found that track power was high maintenance and one of the articles had a list of how to clean the track – the key to cleaning. It shows different cars, home-made cars, a stick and a pad similar to what we use on our HO layout. As they progressed they went to RC control and found it a lot easier to maintain; our is not as big as they are but we do want to run multiple trains. The one gentleman, this company - Rail Links 900 – he offered to do a skype if we wanted to and he offered to talk about his controllers. David had randomly called a few G-scale clubs and all of them gave basically the same answer – you start out small you use track power; you get any bigger than a single loop or a siding you are going to RC. This being the case we should be going to RC. The next issue of the magazine should give more on the RC side. The one guy mentioned that on steam engines the battery can be installed in the tender; other engines the battery can be installed in a car to pull behind the engine and it can be swapped-out.

Bricks: Carol Abraham brought-up the thought of promoting the bricks during the Open House. Jerry Michels noted the idea he had developed for display of the bricks.

Further Discussion: Carol offered an idea of inviting people to bring their own trains to run on the layout. People will need their equipment to be equipped with DCC. There was a bit of discussion on this. This can be noted on the flyer... President Roth noted he will try to get the newsletter out before the flyer. There was further discussion on this with the ultimate goal being to at least make Pampa.

Clinics: No long-term schedule for clinics at the moment.

Tracy Ball offered a short clinic. Lock that indicated it was an ATSF lock but it was not a standard lock. It was a Derail lock that was only used by Car Men. It is a different lock, has a different key; train crews did not have Derail lock keys and Car Men did not have switch lock keys. The purpose was so the train crews could not push a car down in the shops in the Yard. They were only used in the Yard. This lock was specific for use in the Yard. The derails out on the railroad had switch locks.

ARM Work Dates:   October 12  
                          October 26  
                          November 9  
                          November 23

Next Business Meeting: Scheduled Date is Thursday, November 7.

Meeting Adjourned.

---

### **Railroad Historical Events:**

In looking at the NMRA calendar, historical events significant to railroads that occurred during the months of October and November included the following:

Oct. 4, 1922	Canada created the Canadian National Railway and nationalized the system.
--------------	---

Oct. 9, 1863	U.S. Congress sets transcontinental railroad gauge at 4'-8½" (standard gauge).
Oct.27, 1904	New York subway opens.
Nov. 1, 1980	CSX Corporation was formed.
Nov. 7, 1885	Canadian Pacific Railway completed Canada's first transcontinental railroad.
Nov. 18, 1883	U.S. & Canadian railroads first use Standard Time.

**Future Events:**

November 8-10, 2013	Clovis Area Train Society: Model railroad play day at First United Methodist Church in Clovis, New Mexico; 1501 Sycamore Street, Clovis. Set-up on Friday evening 6:00 PM - ? Saturday 9:00 – 5:00; Sunday 12:00 – 3:00 Open to the public.
December 5, 2013	ARM Business Meeting
December 7-8, 2013	Oklahoma City Train Show
July 22-27, 2013	Santa Fe Railway Historical & Modeling Society Convention in Fresno, California

Cleaning Schedule for 2014: Time to pick a month and sign-up.

January	
February	
March	
April	
May	
June	
July	
August	
September	
October	
November	
December	

## Recent Photographs:

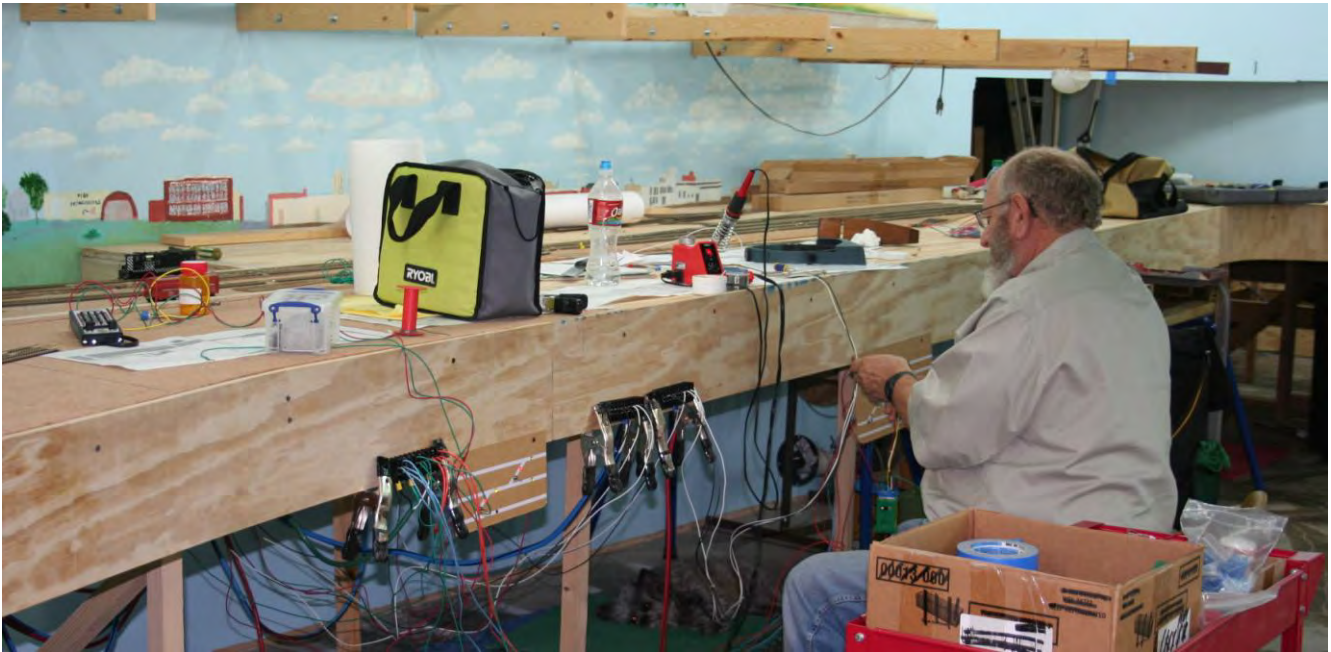

Virgil Doyle working on switch motor controls in the downtown Amarillo area on October 12.



October 12: On the left, the plywood decking at Canadian recently cut but not installed. On the right, Tracy Ball and David Jusiak in the wood shop cutting pieces of spline for the roadbed.



October 26: Left: David Jusiak laying-out turnouts at Pampa. Right: Virgil Doyle has moved-on and is working at Panhandle.



Jerry Michels working on the layout wiring at the North end of Amarillo Junior Yard on October 26.

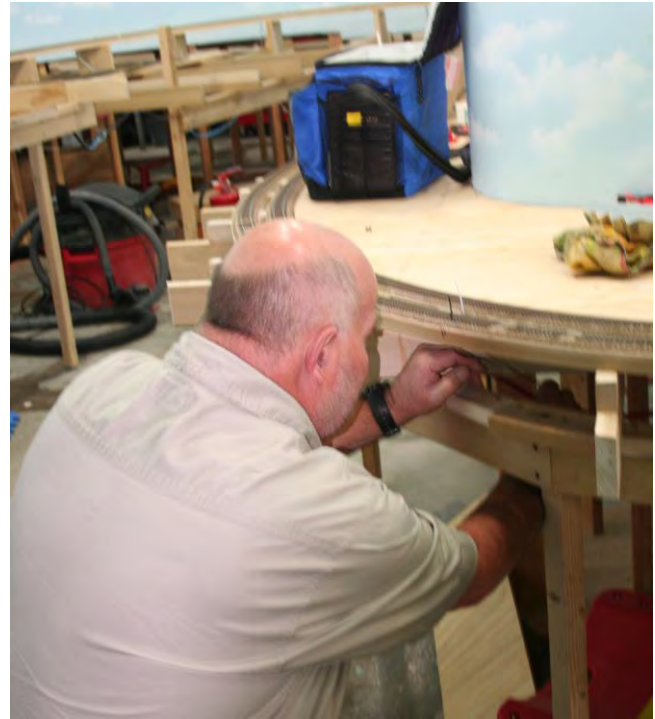

October 26: In the photo on the left is freshly installed track extending from Kingsmill into the West end of Pampa. In the photo on the right, Guy Pigg is installing buss wire to power the track around the end of the peninsula between Kingsmill and Pampa.

Following the October 26 work day a number of ARM members worked a lot of extra hours to get the layout ready for the November 9 Open House. See the photos in the next issue of Run 8.





# Run 8

December, 2013

## President's Message

*By Bob Roth*

As I finally sit down to write this message I would like to belatedly wish all the members of the Amarillo Railroad Museum a Happy Thanksgiving. The month of November was an extremely busy month for us starting with all the preparations in advance of our Open House in recognition of National Model Railroad Month, followed by work to debug problems on the HO scale layout so that we can run trains on the layout. Also, the Potter County Commissioner's Court raised questions about annual expenditures for the Santa Fe Museum during their meeting on November 11 given that no work has been completed to install a Museum in the Santa Fe Buildings and the subject carried-over onto their agenda for November 25 which attracted our attention. I will address each of these subjects in this message.

**The Open House:** As I mentioned in my message last month, all of our "active" members worked a lot of extra hours in the last couple weeks before the Open House in an effort to complete the track around the lower level of the HO scale layout between the Staging Yard and Amarillo Junior Yard; at the same time I was trying to complete the outermost loop of track around the perimeter of the Phillip Pratt Memorial Garden Railroad. Virgil and Paula Young even made it out to the ARM on Saturday, November 2 delivering a number of buildings that will go on the layout. As I promised last month, here is, as Paul Harvey used to say "here is the rest of the story..."

**HO Scale Layout:** Members managed to lay the track all the way around the lower level by-passing all the side tracks at Canadian and omitting the laying of the side tracks at Miami, however trains could not be operated all the way around the lower level of the layout as the segment between Miami and Canadian lacked connection of the power drops from the track and there were some problems with a few shorts and dead spots scattered around the layout. At the least, folks were able to operate trains on part of the layout for the Open House. It took significant work by Tracy, Jerry and Guy over the two weeks following the Open House to identify and correct a number of minor problems including one major short which was impacting the operation of trains on one of the main line, but a declaration was made the lower level is almost complete after the major short was corrected.

**Phillip Pratt Memorial Garden Railroad:** Outside in the garden, I was unable to complete the loop around the garden prior to the November 9 Open House but I had managed to complete the track around the Northwest corner of the garden leaving only the track on the North side of the garden to complete. While this sounds like a simple task, it involved cutting a number of pieces of track to fit

the siding and drilling and tapping holes in those cut ends to accept screws for the rail joiners. The morning of the Open House I took one locomotive out to the garden and set it on the track and verified that it traversed all the way around the track I had completed and while I kept working on the track around the North side of the garden, I periodically stopped working on the track to run the train for some of the visitors. Around 4:30 PM I finally was able to declare victory on the outer loop of track around the garden as I was able to run the locomotive all the way around the loop on track power. The only problem was it ran successfully going only one direction... I have a problem with the turn-out at the West end of the North siding and I have a few ideas how to fix this problem; the issue now is catching some good enough weather so that I can work on it. In the days following the Open House the weather turned cold, too cold to work outside on the garden track thus the corrective work will have to wait for warmer weather. Fortunately the heating system was turned-on inside the building allowing work to be done indoors.

Potter County Commissioners Meetings: During their regularly scheduled meeting on November 11 Potter County Commissioners raised questions concerning county funding for the Santa Fe Museum that had been proposed to be located on the second floor of the Santa Fe Building. Walter Wolfram was not available at that meeting to address the issue thus it was set-aside to be discussed at their next scheduled meeting on November 25. The local news media caught this story and broadcast one part of a comment about the County having paid \$50,000 per year to this Museum Board but had nothing to show for it after several years. Directors Jerry Michels and Guy Pigg managed to attend the Commission meeting on November 25 and hear the presentation Walter Wolfram concerning how the plans for the museum had evolved from installing the Museum on the 2<sup>nd</sup> floor of the Santa Fe Building to newer plans to locate the museum in the Santa Fe Depot which was recently purchased by the City of Amarillo.

Jerry sent notes from this meeting to members of the ARM Board for consideration and discussion at our next Business Meeting. In a nutshell, approximately two years ago Judge Ware and Walter Wolfram decided the Santa Fe Building was not the best place for the museum to be located. Walter set his eyes on the Santa Fe Depot and had some studies conducted to investigate costs for restoration of the Depot and the estimate was around \$1.3 million. Walter has gone on with ideas to bring elements from Jerry Buttel's railroad museum, the ARM, and the Madame Queen all together at the Santa Fe Depot; there is a minor issue that he has not talked with us (and probably the others too) about any such plans for the museum. The County Commissioners asked for financial statements from the museum board and they were promised thus this item will be up for further discussion in the not-too-distant future. For this reason we will plan to have a discussion during our Business Meeting on December 5. Stay Tuned!

News Tidbit: The City of Amarillo sent a response to my request for re-assessment of the City's drainage fee. I had noted that our property drains to the North onto the right-of-way for US Highway 60 and thus does not drain via any City-owned conveyance; they validated this and their letter stated our drainage fees will be waived in the future and the amount we paid these last 3 months will be rebated to the ARM.

Next Meeting: The next Business Meeting would be scheduled on Thursday, January 2 (or 9) at 7:30 PM. As I write this there is no planned clinic following the meeting.

Bob Roth

---

## MEETING MINUTES

### ARM Business Meeting

November 7, 2013

Note: This meeting was shortened as members were working on the HO scale layout in the Layout Room while President Roth conducted the meeting; all effort was focused on preparation for the Open House scheduled on Saturday, November 9.

#### Old Business:

Meeting Minutes from October: Published and distributed via e-mail; Approved as Published.

Treasurer's Report: Treasurer's Report for October: President Roth read the report.

One large expenses was noted where a down-payment was made on the custom cars ordered from Tangent Scale Models.

Treasurer's Report was Approved as Read.

#### Car Sales Report/Update:

Director Jerry Michels reported there were 4 sales this past month. Nothing new this month from Tangent. We are waiting for them to get in touch with us as the car delivery gets closer.

#### Layout Construction:

Progress: Director Tracy Ball reported he had completed laying the spline in Miami and cork had been laid on the spline and we just needed track to be laid; we will have track laid all the way around (from the Staging Yard to Amarillo Junior Yard). It was noted that track was being laid while the meeting was in progress.

#### Phillip Pratt Memorial Garden Railroad:

President Roth reported he had been working on track and is down to just laying track around two curves and the North side of the garden to complete the outer loop of track.

#### Building & Grounds Update:

Tracy Ball had done some mowing around the garden, along the road and in the bar ditch up to the main road, I Avenue.

News of Other Organizations: No recent news from any of the other organizations.

Recent/Current Promotions: Flyers were put out for our Open House had been placed at Hobby Time but not at Amarillo Hobby House. Guy Pigg reported he will be going by there tomorrow and could take some flyers. Tracy Ball is also planning to go by there tomorrow. He will pick-up "Amarillo Railroad Museum is Open" signs which will be ready in the morning and will take them to both Hobby Time and Amarillo Hobby House and will have two additional signs. Wherever we take the signs we can call them up and ask them to post the sign to let people know we are open that day. We can also take them to the Tourist Information Center. Carol Abraham will take one of the signs and some flyers to the tourist bureau. Carol had also done

some promotional work; Chip Chandler will have something that will come-out in the Get-Out section in the news on Friday. Carol noted all three TV stations had been contacted; the guy with Channel 10 is in her AMBUC club. The Chamber had it in their calendar but Carol was not happy with their instruction to call for directions. DJ Stuben has the Eagle ad and she has it in there. Carol noted some kids that go to Carver that had done the Amarillo tourism app; they are the only high school students that had developed an app. Their teacher said they would be here. All Carol's Sunday School class will come and AMBUCS will come. Carol asked if there were any more Phillip Pratt brochures; there was a box full.

#### Movie – The Battle of Adobe Walls:

President Roth stated he had observed mention in the “Get Out” section in Friday’s newspaper (October 25) the movie concerning the battle of Adobe Walls has been delayed until Spring. Carol indicated she had heard this was if they can raise \$4.5 million. The article had not said anything about the need for raising money.

Museum Guide: No further work on draft guide to the ARM this month due to other projects and priorities.

TPRHS Documents: No progress this past month.

Memorial Plaques: No further development.

Housekeeping Schedule: Need to start schedule for 2014.

#### New Business:

##### Drainage Fee:

President Roth contacted the City about the drainage fee and found we had been assessed for 101,158 square feet of impervious surface. He then spent some time measuring the roads plus the assorted concrete pads around the property and came up with an approximate area of around 50,000 square feet. With this information a letter to the City was drafted requesting an adjustment to the drainage fee with some supporting photos; in this letter President Roth also had noted that our property drains to the State highway right-of-way to the North and does not drain into any City conveyance and because of this he is hopeful the City may waive the drainage fee. This was mailed-in earlier this week. There was some discussion on this subject concerning a petition that had been signed by an adequate number of citizens to put the drainage fee to a vote but the petition had been rejected. There is something to come on the drainage fee.

##### Buildings for HO Layout:

Virgil and Paula Young visited the ARM on Saturday, Nov. 2 and they brought a number of building models that are intended to go on the layout, mostly on the upper level so they don't have a home at the moment. The buildings were sitting in the Meeting Room. Tracy Ball noted he planned to clean-out a display cabinet and will put most of these buildings in this display cabinet.

##### Stepping Stones:

Information was received from Paula Young last night; the cost for the ARM to buy the stones was \$55 per stone; this was the price obtained in 2011 thus we don't know if this price is still current. President Roth stated we needed to look at the other bricks Jerry had priced thru Bricks-R-U's previously and set-up appropriate pricing based upon the size of the bricks/stones and also to look at the sources from which we might want to obtain bricks/stones. Carol stated the brochure had indicated a price on the form for selling the stepping stones for \$55; it was stated that we cannot sell the stones for \$55 given that is the cost of the stones and that would not pay for their installation. We will need to hold-off on selling stones but we can tell people we will have some for sale in the future. We need to look at this more closely to develop pricing for the bricks/stepping stones but there is not enough time before the Open House on Saturday.

Clinics: No long-term schedule for clinics at the moment.  
President Roth noted we essentially had a clinic in-progress on track laying.

ARM Work Dates: November 9 – Open House  
November 23  
December 14  
December 28

Next Business Meeting: Scheduled Date is Thursday, December 5.

Meeting Adjourned.

---

### **Railroad Historical Events:**

In looking at the NMRA calendar, historical events significant to railroads that occurred during the month of December included the following:

Dec. 1, 1959	The Norfolk & Western Railway and Virginian Railway merged.
Dec. 12, 1887	The U.S. Congress passed the Interstate Commerce Act.
Dec. 24, 1928	The Great Northern Railroad completed the Cascade Tunnel.
Dec. 26, 1917	U.S. Government temporarily nationalized the nation's railroads for WWI.

### **Future Events:**

December 5, 2013	ARM Business Meeting
December 7-8, 2013	Oklahoma City Train Show
January 2, 2014	ARM Business Meeting
July 22-27, 2013	Santa Fe Railway Historical & Modeling Society Convention in Fresno, California

---

Cleaning Schedule for 2014: Time to pick a month and sign-up.

January	
February	
March	
April	
May	
June	
July	
August	
September	
October	
November	
December	

---

Recent Photographs:



This was the starting point for the garden railroad on the day of our Open House on November 9. The loop was completed late that day and the train was able to go all the way around the garden on track power.



November 9: On the left, track is laid thru Canadian, Texas coming from the lower Staging Yard and heading toward Miami on the far end where David Jusiak is leaning against the bench. On the right, the main line track is laid thru Miami. Contrast these pictures with the progress pictures from last month...

#### Historical Tidbit: Standard Time

On November 18, the Amarillo Globe-News in their "Today in History" column noted the US and Canada had implemented Standard Time back in 1883. As stated, the information was not entirely correct.

In 1883 it was the railroads in the US and Canada that implemented Standard Time. As things existed up until then, time was kept locally and it was noon when the sun was directly overhead. This made it extremely difficult for the railroads to set-up timetable schedules because the time changed everywhere particularly as you moved East or West.

The implementation of Standard Time by the railroads upset a lot of people at the time because it was not "God's time." People did adapt over a period of time and by the time the US entered WWI, the country was essentially running on Standard Time. The US Congress did not formally adopt Standard Time until 1918.



November 23: Left: David Jusiak laying track on the sidings at Miami. Right: Guy Pigg is using a meter to check continuity while looking for a short in the track power feed.



Jerry Michels soldering a drop on the frog of a turn-out in the East Tower area on November 23. It was cold inside the Train Room that day due to extremely cold temperature outside with strong North winds.





November 23: Virgil Doyle is working on installation of switch motors at the West end of Panhandle. Note his helper in his lap.



November 23: View of the layout from the landing at the top of the stairs.